

Boiler regulator ecoMAX 800, model R1

version: ec

FOR SOLID FUEL-FIRED BOILERS WITH FEEDING SCREW



Individual
Fuzzy Logic

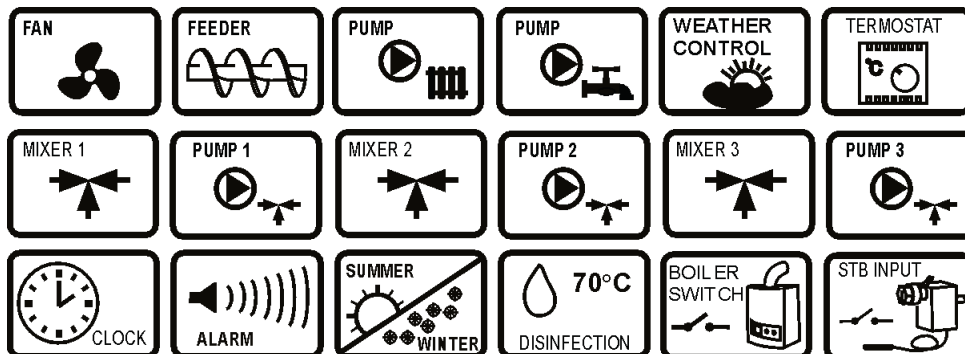

SERVICE AND ASSEMBLY MANUAL ISSUE: 1.2

APPLICABLE TO
SOFTWARE:

MODULE
v06.11.030
v06.11.031
v06.11.035
v06.11.036
v06.11.037

PANEL
v06.10.014
v06.10.015
v06.10.016
v06.10.017

2010-04-09

TABLE OF CONTENTS

1	RECOMMENDATIONS REGARDING SAFETY.....	5	13.1	ENVIRONMENTAL CONDITIONS.....	25
2	GENERAL INFORMATION.....	6	13.2	INSTALLATION REQUIREMENTS.....	25
3	INFORMATION ABOUT DOCUMENTATION.....	6	13.3	INSTALLATION OF CONTROL PANEL.....	25
4	STORAGE OF DOCUMENTATION.....	6	13.4	EXECUTIVE MODULE INSTALLATION.....	26
5	APPLIED SYMBOLS.....	6	13.5	IP PROTECTION RATE.....	27
6	DIRECTIVE WEEE 2002/96/EG.....	6	13.6	CONNECTING ELECTRICAL SYSTEM.....	27
	REGULATOR INSTRUCTION MANUAL.....	7	13.7	PROTECTIVE CONNECTIONS.....	28
7	STRUCTURE – MAIN MENU.....	8	13.8	CONNECTING TEMPERATURE SENSORS.....	29
8	OPERATING THE REGULATOR.....	9	13.9	CONNECTING WEATHER SENSOR.....	29
8.1	DESCRIPTION OF BUTTONS.....	9	13.10	CHECKING TEMPERATURE SENSORS.....	29
8.2	DESCRIPTION OF DISPLAY MAIN WINDOW.....	9	13.11	CONNECTING ROOM THERMOSTAT.....	30
8.3	START-UP OF THE REGULATOR.....	9	13.12	CONNECTING RESERVE BOILER.....	30
8.4	PRESETTING BOILER TEMPERATURE.....	9	13.13	CONNECTION OF ALARM SIGNALLING.....	32
8.5	STOP.....	10	13.14	CONNECTING MIXER.....	33
8.6	FIRING UP.....	10	13.15	CONNECTING TEMPERATURE LIMITER.....	34
8.7	OPERATION – MANUAL SETTINGS.....	11	13.16	CONNECTING ADDITIONAL PANEL.....	34
8.8	OPERATION – FUZZY LOGIC SETTINGS.....	12			
8.9	CONTROL.....	12	14	BOILER SERVICE SETTINGS.....	35
8.10	FUEL SELECTION.....	14	14.1	INSTALLATION TYPE.....	35
8.11	SETTINGS FOR DOMESTIC HOT WATER (DHW).....	14	14.2	ROOM THERMOSTAT OF THE BOILER.....	35
8.12	PRESETTING DOMESTIC HOT WATER TEMPERATURE.....	14	14.3	BOILER WEATHER CONTROL.....	35
8.13	ENABLING THE SUMMER FUNCTION.....	14	14.4	HEATING CURVE.....	35
8.14	DHW TANK DISINFECTION.....	14	14.5	BOILER HYSTERESIS.....	35
8.15	MIXER SETTINGS.....	15	14.6	MINIMUM PRESET BOILER TEMPERATURE.....	35
8.16	WEATHER CONTROL.....	15	14.7	MAXIMUM PRESET BOILER TEMPERATURE.....	35
8.17	DESCRIPTION OF SETTING NIGHT-TIME DECREASES.....	15	14.8	MINIMUM FAN POWER.....	36
8.18	INFORMATION.....	16	14.9	FUEL SHORTAGE DETECTION TIME.....	36
8.19	DISABLING FEEDER.....	16	14.10	FEED TIME CONTROL.....	36
8.20	MANUAL CONTROL.....	17	14.11	EXTENDING AIRFLOW OPERATION.....	36
8.21	RESTORING USER SETTINGS.....	17	14.12	MAXIMUM FEEDER TEMPERATURE.....	36
	REGULATOR INSTALLATION AND SERVICE SETTINGS MANUAL.....	19	14.13	MIN. RETURN TEMPERATURE.....	36
9	STRUCTURE - SERVICE MENU.....	20	14.14	RETURN TEMPERATURE HYSTERESIS.....	36
10	HYDRAULIC DIAGRAMS.....	22	14.15	RETURN PROTECTION.....	36
11	TECHNICAL DATA.....	25	14.16	RESERVE BOILER.....	36
12	CONDITIONS OF STORAGE AND TRANSPORT..	25	14.17	ALARMS – SIGNALLING SETUP.....	37
13	REGULATOR INSTALLATION.....	25	14.18	BOILER COOLING TEMPERATURE.....	37
			15	CH AND DHW SERVICE SETTINGS.....	37
			15.1	CH START TEMPERATURE.....	37
			15.2	CH PUMP STANDSTILL TIME.....	37
			15.3	CH PUMP STANDSTILL WITH DHW PRIORITY.....	37
			15.4	MAXIMUM DHW TEMPERATURE.....	37
			15.5	DHW TANK HYSTERESIS.....	37
			15.6	INCREASE IN BOILER TEMPERATURE AN ACCOUNT OF DHW AND MIXER.....	38
			15.7	EXTENDING DHW PUMP.....	38
			16	MIXER SERVICE SETTINGS.....	38
			16.1	MIXER OPERATION.....	38
			16.2	MAX. PRESET MIXER TEMPERATURE.....	38
			16.3	MIN. PRESET MIXER TEMPERATURE.....	38
			16.4	RANGE OF PROPORTIONALITY.....	38

16.5	INTEGRATION TIME CONSTANT	39
16.6	VALVE OPENING TIME	39
16.7	INCREASE IN BOILER TEMPERATURE ON ACCOUNT OF MIXER	39
17	RESTORING SERVICE SETTINGS	39
18	DESCRIPTION OF ALARMS	40
18.1	NO FUEL	40
18.2	EXCEEDING MAX. BOILER TEMPERATURE	40
18.3	EXCEEDING MAX. FEEDER TEMPERATURE	40
18.4	DAMAGE TO BOILER TEMP. SENSOR	41
18.5	FEEDER TEMPERATURE SENSOR DAMAGE	41
18.6	NO COMMUNICATION.....	41
19	EXTRA FUNCTIONS	43
19.1	POWER SUPPLY DECAY	43
19.2	PROTECTION AGAINST FREEZING	43
19.3	PREVENTIVE COOLING	43
19.4	FUNCTION OF PROTECTING PUMPS AGAINST STAGNATION.....	43
20	REPLACEMENT OF PARTS AND SUBASSEMBLIES	
	43	
20.1	REPLACING MAINS FUSE	43
20.2	CONTROL PANEL REPLACEMENT	43
20.3	EXECUTIVE MODULE REPLACEMENT	44
21	DESCRIPTION OF POSSIBLE FAULTS.....	45
22	REGULATOR SETUP BY BOILER MANUFACTURER.	47

1 RECOMMENDATIONS REGARDING SAFETY

Requirements concerning safety are described in detail in individual chapters of this manual. Apart from them, the following requirements should in particular be observed:



- ⇒ Before starting assembly, repairs or maintenance, as well as during any connection works, please make sure that the mains power supply is disconnected and that terminals and electric wires are devoid of voltage.
- ⇒ After the regulator is turned off using the keyboard, dangerous voltage can occur on the terminals.
- ⇒ The regulator cannot be used at variance with its purpose.
- ⇒ Additional automatics which protect the boiler, central heating (CH) system, and domestic hot water system against results of malfunction of the regulator, or of errors in its software, should be applied.
- ⇒ Choose the value of the programmed parameters accordingly to the given type of boiler and fuel, taking into consideration all the operational conditions of the system. Incorrect selection of the parameters can cause malfunction of the boiler (e.g. overheating of the boiler, the flame going back to the fuel feeder, etc.),
- ⇒ The regulator is intended for boiler manufacturers. Before applying the regulator, a boiler manufacturer should check if the regulator's mating with the given boiler type is proper, and whether it can cause danger.
- ⇒ The regulator is not an intrinsically safe device, which

means that in the case of malfunction it can be the source of a spark or high temperature, which in the presence of flammable dusts or liquids can cause fire or explosion. Thus, the regulator should be separated from flammable dusts and gases, e.g. by means of an appropriate body.

- ⇒ The regulator must be installed by a boiler manufacturer in accordance with the applicable safety standards.
- ⇒ The programmed parameters should only be altered by a person familiarized with this manual.
- ⇒ The device should only be used in heating systems in accordance with the applicable regulations.
- ⇒ The electric system in which the regulator operates must be protected by means of a fuse, selected appropriately to the applied loads.
- ⇒ The regulator cannot be used if its casing is damaged.
- ⇒ In no circumstances can the design of the regulator be modified.
- ⇒ Electronic isolation of the connected devices is applied in this regulator (action type Y2 acc. to PN-EN 60730-1).
- ⇒ The regulator consists of two subassemblies. In the case of replacing one subassembly, make sure to maintain compatibility with the other one. More information on that issue can be found in the documentation intended for fitters.
- ⇒ Keep the regulator out of reach of children.

2 General information

The ecoMAX 800 boiler regulator, model R1, version ec, is a modern electronic device the purpose of which is to control operation of a coal-fired boiler with a feeding screw. The regulator is a multipurpose device:

- it automatically maintains a preset boiler temperature by controlling the fuel combustion process,
- it controls timing of feeding screw and fan,
- it automatically stabilizes a preset temperature of the domestic hot water tank,
- it automatically maintains a preset temperature of one heating mixer cycle, and after equipping the regulator with an extension module, it controls (altogether) operation of three heating mixer cycles,

The preset temperature of heating cycles and boiler can be set on the basis of a weather sensor readouts.

The regulator features an individual fuzzy logic function. It allows to optimize the combustion process, which is in favour of natural preservation, decreases fuel consumption and relieves the user of the necessity of adjusting the burner parameters.

Possibility of cooperation with room thermostats, separate for each heating cycles, facilitates maintaining comfortable temperature in the heated rooms. Moreover, if need arises, the device enables a reserve boiler (gas- or oil-fired).

The device has modular construction, consisting of a control panel, the main executive module, and, optionally, a control module for two additional mixer cycles.

The device is operated in an easy and intuitive way.

Regulator can cooperate with an additional control panel situated in living quarters. It can be used in a household and similar facilities, as well as in light industrialized facilities.

3 Information about documentation

The regulator manual is a supplement for the boiler manual. In particular, except for this manual, the boiler manual should also be

observed. The regulator manual is divided into two parts: for user and fitter. Yet, both parts contain important information, significant for safety issues, hence the user should read both parts of the manual.

We are not responsible for any damages caused by failure to observe these instructions.

4 Storage of documentation

This assembly and operation manual, as well as any other applicable documentation, should be stored diligently, so that it was available at any time. In the case of removal or sale of the device, the attached documentation should be handed over to the new user / owner.

5 Applied symbols

In this manual the following graphic symbols are used:



- useful information and tips,



important information, failure to observe these can cause damage of property, threat for human and household animal health and life.

Caution: the symbols indicate important information, in order to make the manual more lucid. Yet, this does not exempt the user from the obligation to comply with requirements which are not marked with a graphic symbol.

6 Directive WEEE 2002/96/EG

Act on electrical and electronic equipment



- ⇒ Recycle the product and the packaging at the end of the operational use period in an appropriate manner.
- ⇒ Do not dispose of the product together with normal waste,
- ⇒ Do not burn the product.

REGULATOR INSTRUCTION MANUAL

ecoMAX 800, model R1

7 Structure – main menu

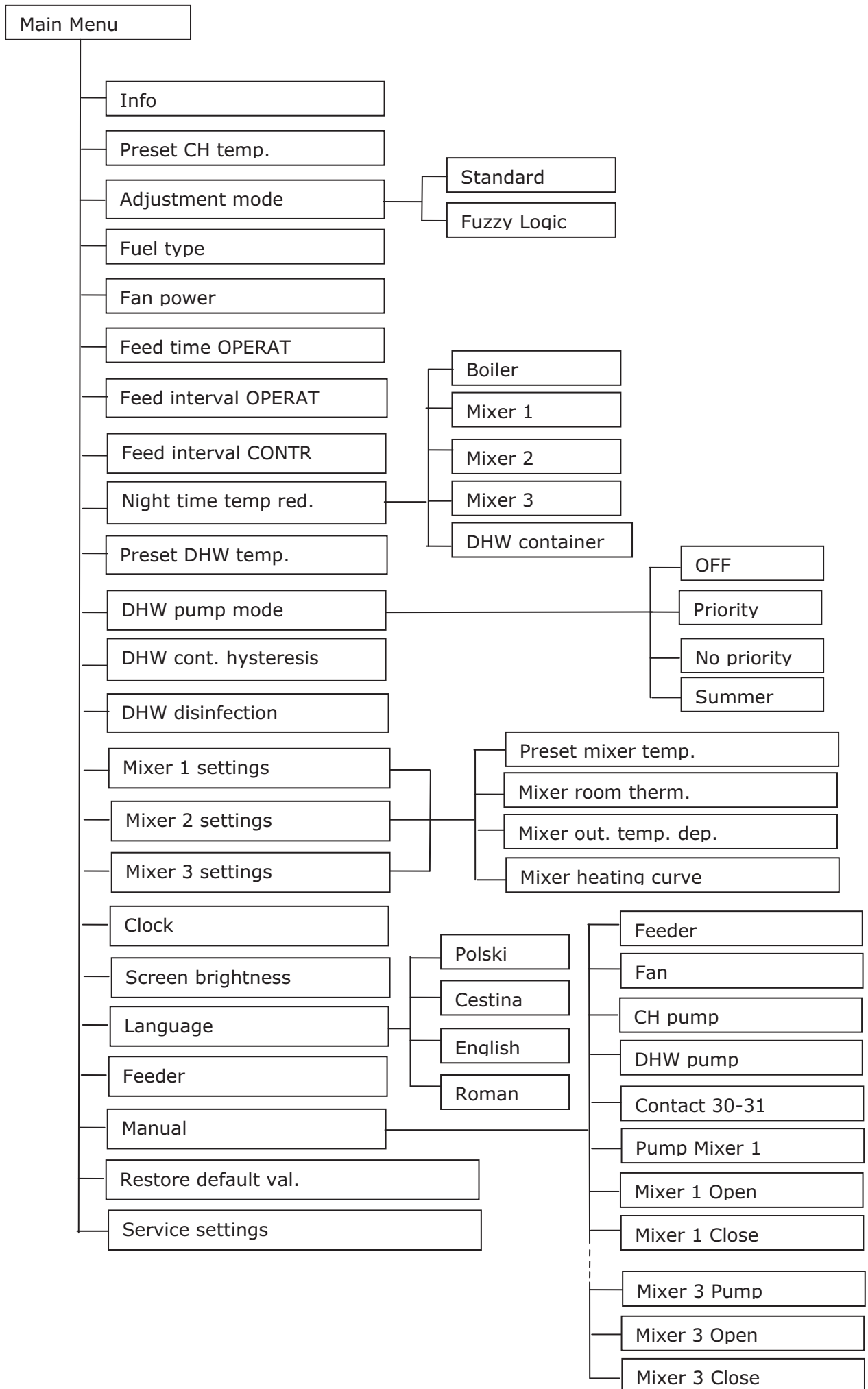

8 Operating the regulator

This section briefly describes how the regulator should be operated. In order to start using a boiler with the regulator, you must fire the boiler up using the regulator mode LIGHT, and then switch the regulator into the mode OPERATION.

8.1 Description of buttons

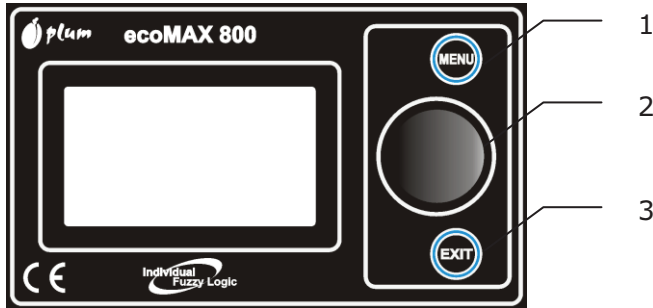

Drawing 1 View of control panel

Legend:

1. MENU button
2. „TOUCH and PLAY“ knob
3. EXIT button

Turning the “TOUCH and PLAY” knob increases or decreased the edited parameter. This is an element of quick operation of the regulator. Pushing this knob allows to enter the given parameter, or to confirm the selected value.

8.2 Description of display main window

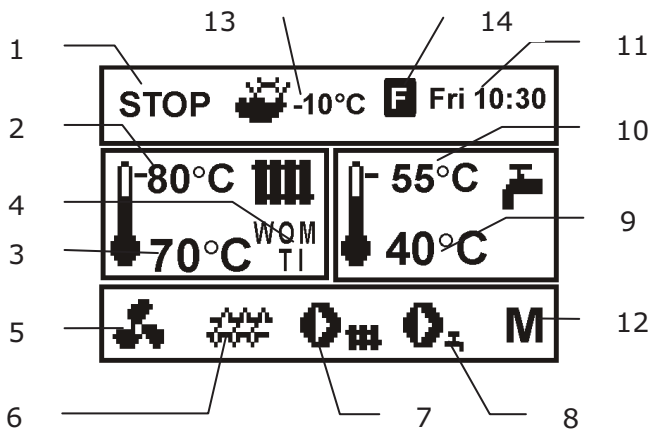

Drawing 2 display main window

Legend:

1. regulator operation modes: STOP, LIGHT, OPERATION, CONTROL,
2. preset boiler temperature,
3. measured boiler temperature,

4. field of values which influence the preset boiler temperature: „T” – symbol of decrease in the preset boiler temperature due to disconnection of the room thermostat contacts; „I” symbol of decrease in the preset boiler temperature due to active intervals; „W” – symbol of increase in the preset boiler temperature for the time of filling the domestic hot water (DHW) tank; „M” - symbol of increasing the preset boiler temperature due to mixer cycle; „O” - weather control for the boiler cycle enabled.
5. airflow operation symbol
6. fuel feeder operation symbol,
7. central heating pump operation symbol,
8. domestic hot water pump operation symbol,
9. measured temperature of domestic hot water tank,
10. preset temperature of domestic hot water tank,
11. clock and day of the week
12. symbol of mixer extension module MX.01, which allows support of two additional heating cycles
13. outside (weather) temperature,
14. active fuzzy logic control symbol.

The domestic hot water window in the main screen can be changed into a selected mixer cycle using the TOUCH and PLAY knob.

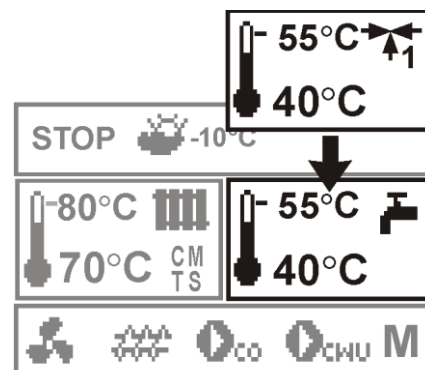

Drawing 3 auxiliary window, note: the windows for mixers 2 and 3 appear only if the additional mixer module MX.01 is equipped.

8.3 Start-up of the regulator

The regulator is switched on by pressing the “TOUCH and PLAY” knob. First, an information window with the software versions appears, then the regulator switches to the STOP operation mode.

8.4 Presetting boiler temperature

Specify the preset boiler temperature by entering:

MENU -> Preset CH temp.

and setting this parameter at the desired value.

The preset boiler temperature can be also set at the main window. Press the "TOUCH and PLAY" knob in the main window and turn it to specify the preset boiler temperature – the temperature "pulsates". Confirm the settings by pressing the "TOUCH and PLAY" knob once more. In order to exit the temperature editing, press the EXIT button.

Pressing EXIT when the parameter - e.g. the preset boiler temperature - „pulsates“ makes the regulator discard the specified value. To make the regulator store the preset value, confirm it by pressing the "TOUCH and PLAY" knob.



The regulator skips the *preset CH temp.* parameter when the preset boiler temperature is determined in relation to the weather. The preset boiler temperature is temporarily increased in order to fill the domestic hot water tank, and the mixer cycles.

8.5 STOP

After its activation, the regulator is in the STOP mode. The STOP mode can be also enabled by selecting the STOP operation mode in the main window and pressing the „TOUCH and PLAY“ knob.

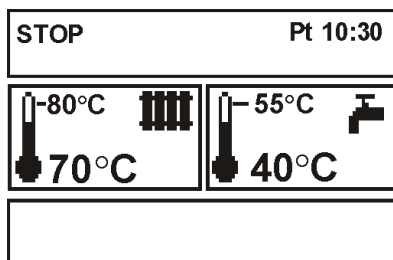

Drawing 4 View of the main window in the STOP mode

In this mode, the following executive devices are disabled: blower, feeder, - CH pump and DHW pump. The mixer (pump and servo) stays active.



In the STOP mode, the CH pump is turned off, which can increase the boiler temperature.

8.6 FIRING UP

Enter the LIGHT mode by selecting the LIGHT operation mode and pressing the "TOUCH and PLAY" button.

The LIGHT mode is used to fire up the furnace in the boiler. In this mode, the user can manually control the airflow and the fuel feeder. The boiler should be fired up in strict accordance with the boiler manufacturer's recommendations.

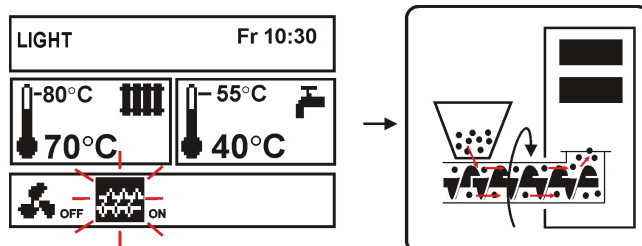

Drawing 5 Manual start-up of the feeder

Pressing the „TOUCH and PLAY“ knob on the feeder symbol activates it, which is signalled by an ON sign next to this symbol. Feed the fuel until it appears at the end of the retort.

Press the knob again to turn the feeder off. Next, put some kindling (e.g. for barbecue) under the layer of fuel and light it.

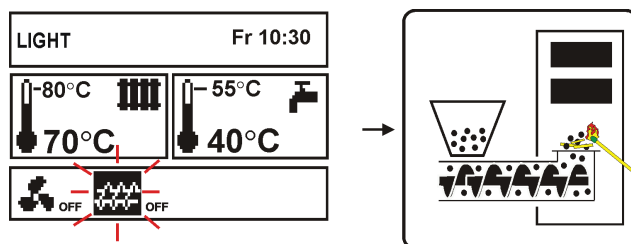

Drawing 6 Disabling the feeder during firing up

Pressing the "TOUCH and PLAY" knob on the airflow symbol activates it, which is signalled by an ON sign next to this symbol. Press the "TOUCH and PLAY" knob again to turn the airflow off. Light the fed fuel up and, once in a while, feed another dose of the fuel.

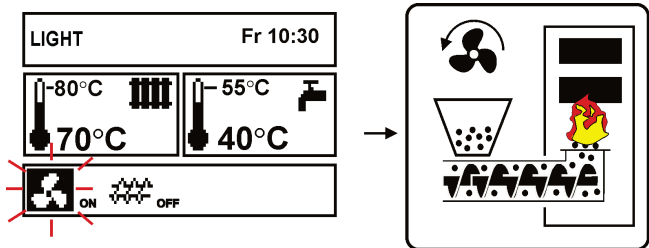

Drawing 7 Manual activation of airflow

 The fan power can be set by pressing the MENU button and setting the *fan power* parameter

After making sure that the fire in the furnace is lit up properly, disable the fan and the feeder, and exit the LIGHT mode by pressing the EXIT button. At this moment the regulator will by default switch to the OPERATION mode. The sign OPERATION will appear in the upper left corner. At that time, the regulator works in the automatic cycle.

 Shall the user forget to switch the regulator into the OPERATION mode, the regulator will continue to heat the boiler until reaching the *preset CH temperature + 5°C*. Then, it will automatically switch into the OPERATION mode, and, as a result, into the CONTROL mode, on account of the fact that the preset boiler temperature has been reached.

 If the boiler temperature is higher than the *preset CH temperature + 5°C*, the LIGHT mode cannot be enabled. In order to do so, increase the preset CH temperature, or wait until the boiler cools down.

8.7 OPERATION – manual settings

The regulator offers two modes of controlling the boiler furnace: manual setting – Standard mode, described in this section of the manual, and automatic setting – Fuzzy Logic¹.

¹ Fuzzy Logic available only in special versions of the regulator

In order to enable the Standard regulation mode, enter: MENU -> Adjustment mode, and place the cursor on „Standard“.

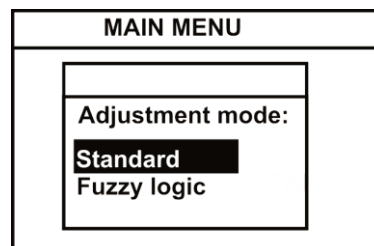

Drawing 8 Selecting the Adjustment mode

In the *Standard* regulation mode, the regulator operates in the automatic cycle with user-defined settings. View of the display

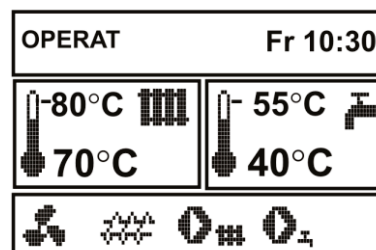

Drawing 9 View of the main window in the OPERATION mode

The regulator can be switched into the OPERATION mode while skipping the LIGHT mode. To do so, select the OPERATION mode in the main window and push the „TOUCH and PLAY“ knob.

After switching over to the OPERATION mode, the airflow is activated 5s earlier than the feeder, and it works constantly, as presented in Drawing 10. The fuel feeder is enabled cyclically. A cycle consists of the feeder operation time (*feed time OPERAT*), and the interval between feeding (*feed interval OPERAT*). These times should be set in accordance with the boiler manufacturer's recommendations.

In order to ensure proper operation of the boiler, set these parameters, as well as the *fan power*, to match the amount and type of fuel.

Feeder operation time, feeding interval and fan power can be set in:

MENU -> FEED TIME OPERAT

MENU -> FEED INTERVAL OPERAT

MENU -> FAN POWER

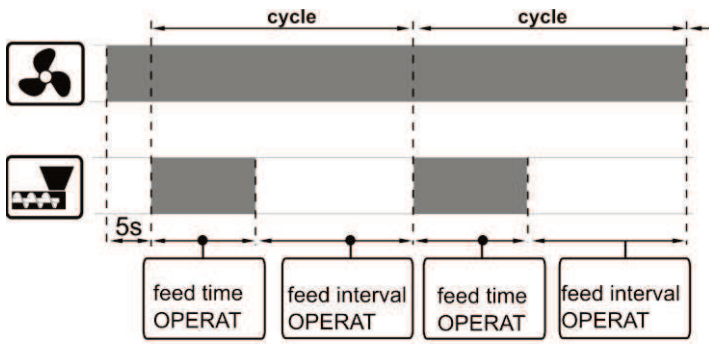

Drawing 10 Airflow and feeder operation cycles in the OPERATION mode.



THE MANUFACTURER'S SETTINGS DO NOT ALWAYS MATCH THE GIVEN BOILER TYPE, THUS THEY MUST BE ADJUSTED TO THE GIVEN TYPE OF BOILER AND FUEL



The *feeding time* and *feeding interval* should be selected in such a way that the fuel would not recede to the fuel feeder.

If in this mode the room thermostat disconnects its contacts, thus signalling that the preset temperature has been reached in the room, then the regulator:

- lowers the preset CH temperature by the parameter *Lower preset CH temp. to thermostat*
(MENU → SERVICE SETTINGS → PASSWORD → BOILER SETTINGS → ROOM THERMOSTAT), thus switching into the CONTROL mode,
- disables the CH pump by the time *CH pump start temp. with thermostat on*
(MENU → SERVICE SETTINGS → PASSWORD → CH/DHW SETTINGS → CH STANDSTILL.

Detailed information about the regulator's cooperation with a room thermostat can be found in section 13.11.

If in the OPERATION mode it is necessary to fill the DHW tank, the regulator will increase the preset boiler temperature, fill the DHW tank, and return to the original settings.

After reaching the preset CH temperature, the regulator automatically switches into the CONTROL mode.

8.8 OPERATION – Fuzzy logic settings

After switching the boiler adjustment mode from Standard to Fuzzy Logic, the regulator works in the OPERATION mode without the need of programming the following parameters: *feed time OPERAT*, *feed interval OPERAT*, *fan power*. The regulator selects the parameters to optimize the combustion process.



It is advised to fire the boiler up using the LIGHT mode and wait until the combustion process stabilizes before enabling the fuzzy logic control.

In order to enable the Fuzzy logic regulation mode, enter: MENU → ADJUSTMENT MODE, and place the cursor over „Fuzzy logic“.

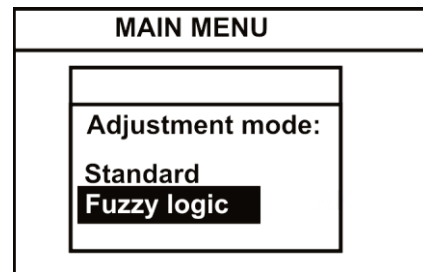

Drawing 11 Selecting the adjustment mode

Please note that the fuzzy logic program is selected individually for the given type of the boiler and fuel, and it can work properly only with this boiler and fuel. It is recommended to keep the fuel dry.



The type of boiler and fuel to which the regulator is set is specified in the fuel selection menu: MENU → FUEL TYPE



With the fuzzy logic regulation, the fan aperture should be maximally opened, and the boiler should be clean. In the case of changing the fan or the feeder, replace them with identical types.



In the fuzzy logic regulation, the value of the *fan power* parameter is not taken into account in the regulator operation algorithm.

8.9 CONTROL

The CONTROL mode can be active both during manual and automatic (Fuzzy Logic) regulation.

The regulator switches into the CONTROL mode automatically, without the user's interference:

- in *Standard* regulation mode – after reaching the preset boiler temperature,
- in *Fuzzy logic* regulation mode – after exceeding the preset CH temperature by + 5°C. In the Fuzzy logic mode, the regulator tries not to switch into CONTROL and to supply as much heat as the CH system requires at the time.

In the CONTROL mode, the regulator supervises the furnace, so that it would not go out. For this purpose, the airflow and the feeder are activated only once in a while, less frequently than in the OPERATION mode. There is no further increase in temperature.

The airflow does not work continuously, it is enabled cyclically, together with the fuel feeder, which prevents the flame from going out during the boiler standstill.

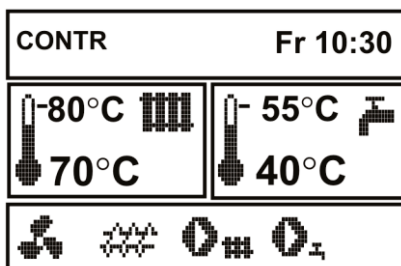

Drawing 12 View of the main window in the CONTROL mode

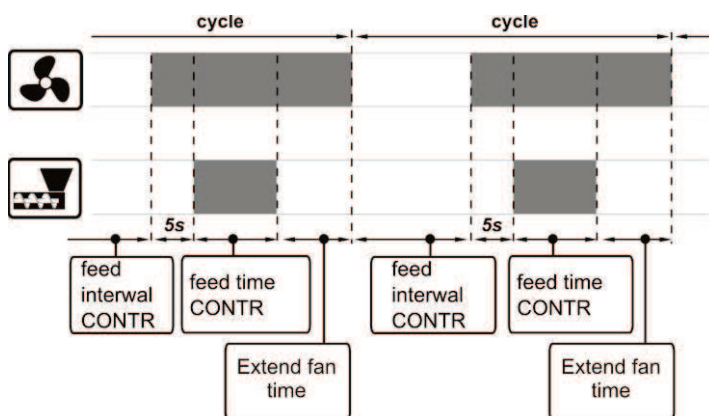

Drawing 13 Fan and feeder operation cycles in the CONTROL mode

The interval between operations of airflow and feeder is determined by the parameter *feed interval CONTR* available in:

MENU -> FEED INTERVAL CONTR

This time should be set in accordance with the boiler manufacturer's recommendations. The time should be chosen bearing in mind, that too long an interval can make the furnace fall in during the boiler standstills, yet setting an insufficient time will lead to an increase in the boiler temperature. The feeder and airflow operation time in the CONTROL mode is set using the parameter *feed time CONTR*, available in:

MENU -> SERVICE SETTINGS -> BOILER SETTINGS -> FEED TIME CONTR

The time of *extend fan time* in order to fire up the fuel after it has been fed is set in:

MENU -> SERVICE SETTINGS -> BOILER SETTINGS -> EXTEND FAN TIME



Set the parameters *feed interval CONTR*, *feed time CONTR* and *extend fan time* to allow the boiler temperature gradually drop in this mode. Wrong settings can make the boiler overheat.



The regulator automatically extends the time of *feed interval CONTR* by half if the boiler temperature exceeds the preset CH temperature by 3°C, and extends it twofold if the boiler temperature exceeds the preset boiler temperature by 5°C.

In the CONTROL mode, the fan works with identical power as in the OPERATION mode, equal to the *fan power* parameter.

If in this mode the room thermostat disconnects its contacts, thus signalling that the preset temperature has been reached, then the regulator:

- lowers the preset CH temperature by the parameter decrease in temperature on account of thermostat (MENU -> SERVICE SETTINGS -> PASSWORD -> BOILER SETTINGS -> ROOM THERMOSTAT),
- disables the CH pump for the *CH pump start temp. with thermostat on* (MENU -> SERVICE SETTINGS -> PASSWORD -> CH/DHW SETTINGS -> CH STANDSTILL).

Detailed information regarding the thermostat can be found in section 13.11.

The regulator automatically returns to the OPERATION mode once the boiler temperature decreases by the value *boiler hysteresis* in relation to the preset temperature.

8.10 Fuel selection

The fuel selection menu is intended only for the FUZZY LOGIC regulation mode. Choose the appropriate type of fuel, accordingly to the fuel used in the boiler.

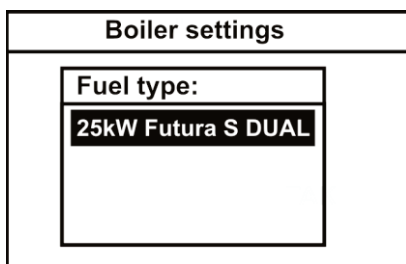

Drawing 14 Fuel selection

In the STANDARD regulation mode, the user must choose the values of the burner parameters on their own.

8.11 Settings for domestic hot water (DHW)

The device regulates the temperature of the domestic hot water tank, provided that a DHW temperature sensor is connected. If the sensor is disconnected, appropriate notification is displayed in the main window. Using the *DHW pump mode* parameter, the user can:

- *disable* feeding of the tank, parameter **OFF**,
- set DHW priority using the **priority** parameter - in this case, the CH pump is off and the mixer is closed in order to fill the DHW tank faster,
- enable simultaneous operation of the CH and DHW pump using the parameter **no priority**

8.12 Presetting domestic hot water temperature

The DHW temperature can be preset by entering:

MENU -> PRESET DHW TEMP.

and set this parameter at the desired value.

The preset domestic hot water temperature can be also set at the main window. Press the „TOUCH and PLAY“ knob in the main window. The preset boiler temperature flashes, press the knob again to make the DHW temperature flash – you can set it then.

Press the „TOUCH and PLAY“ knob to preset the domestic hot water temperature. Confirm the settings by pressing the “TOUCH and PLAY“ knob once more. In order to exit the temperature editing, press the EXIT button.

8.13 Enabling the SUMMER function

In order to enable the SUMMER function, which allows to fill the domestic hot water tank in the summer without the need of warming the central heating system and the mixer cycles, set the parameter *DHW pump mode* to *summer*.

MENU -> DHW PUMP MODE



The SUMMER function cannot be enabled if the domestic hot water sensor is disconnected.



Do not enable the summer function if the DHW pump is disconnected or damaged

8.14 DHW tank disinfection

The regulator has a function of automatic, periodical heating of the DHW water tank to 70°C. The purpose of this is to eradicate bacterial flora from the DHW tank.



The household members must be notified about the fact of enabling the disinfection function, as it carries the risk of scalding with hot water.

Once per week, on Sunday at 02:00 a.m., the regulator increases the DHW tank temperature. After 10 minutes of keeping the tank at this temperature, the DHW pump is turned off, and the boiler resumes normal operation. The disinfection function should not be activated if the DHW support is disabled.

8.15 Mixer settings

Settings of the mixer can be found in:

MENU -> MIXER 1 SETTINGS

The preset temperature of mixer cycle 1 can be specified:

- manually, by setting the parameter *preset mixer temperature* at the required value, or
- in relation to weather, by enabling weather control and choosing the appropriate heating curve.

In order to enable the weather control, weather sensor must be connected. After connecting the sensor, set the parameter *Mixer out. temp. dep.* to *on*.

The mixer heating cycle can include a room thermostat, which lowers the preset temperature by the given value, both with manual and weather control.



After attaching an additional module, the regulator can be extended by 2 additional heating cycles.

8.16 Weather control

Weather control can be enabled both for the boiler cycle, and for the mixer cycle. After selecting appropriate heating curve, the preset temperature of boiler or mixer is calculated automatically, depending on the outdoor temperature. If the heating curve is appropriate for the given building too, this allows to maintain a constant temperature inside, regardless of the temperature outside. Therefore, it is crucial to select a proper heating curve.

Guidelines for setting proper heating curve:

- floor heating 0,2 - 0,6
- radiator heating 1,0 - 1,6
- boiler 1,8 - 4

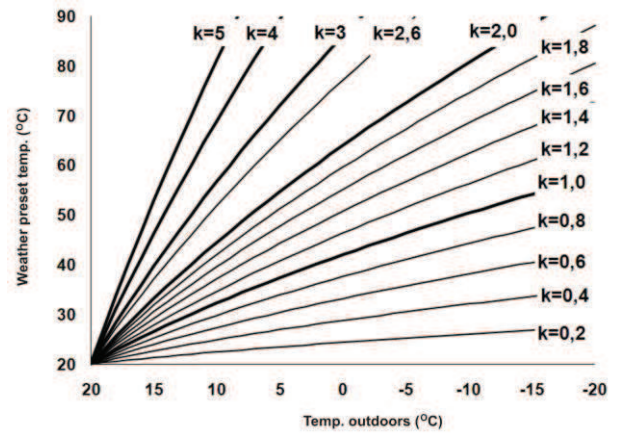

Drawing 15 heating curves:

Tips for selecting appropriate heating curve:

- if the temperature inside rises while the temperature outside drops, the selected heating curve is too high,
- if the temperature inside drops while the temperature outside drops as well, the selected heating curve is too low.

Poorly insulated buildings require higher heating curves. Whereas for well-insulated buildings the heating curve will be lower.

The regulator can increase or decrease the preset temperature calculated in the basis of the heating curve if it goes beyond the temperature range for the given cycle.

8.17 Description of setting night-time decreases

In the regulator menu, you can set time periods for: boiler, heating cycles, and domestic hot water tank.

The time periods allow to lower the preset temperature in the given time period, e.g. at night, or when users leave the heated rooms, e.g. when they go to work. This allows to decrease the temperature automatically, which increases thermal comfort and decreases fuel consumption.

In order to activate the time periods, set the parameter *Night time temp. red.* to *on* in:

MENU -> NIGHT TIME TEMP. RED.

The night-time decreases can be specified separately for weekdays, Saturday and Sunday.

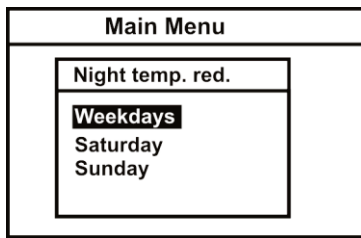

Drawing 16 Time periods selection window

Choose the beginning and the end of the given time period, as well as the decrease in the preset temperature for the given period. Three periods during 24 hours are available.

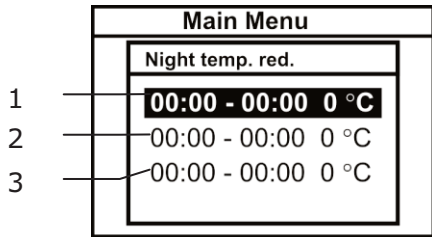

Legend:

1. First time period,
2. Second time period,
3. Third time period.

Below is an example of how to specify time periods. The following example assumes night-time decrease in the preset CH temperature lasting from 22:00 till 06:00 (sleeping time), as well as another decrease between 09:00 and 15:00 (when the household members leave the heated rooms – in order to go to work and to school).

 Start defining the time periods from 00:00 (midnight).

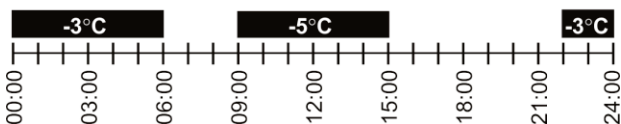
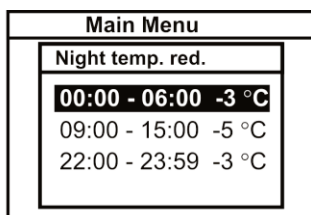

Drawing 17 Example of defining time periods

In the example above, the regulator will decrease the preset CH temperature by 3°C between 00:00 and 06:00. Between 06:00 and 09:00, the regulator will keep the preset boiler temperature unchanged. Between

09:00 and 15:00, the regulator will lower the preset CH temperature by 5°C. Between 15:00 and 22:00, the regulator will keep the preset CH temperature unchanged. Between 22:00 and 23:59, the regulator will lower the preset boiler temperature by 3°C.

 The time period is skipped if its decrease value is 0, even if hours are specified.

 Decrease in the preset boiler temperature on account of time period is signalled by letter „S” displayed in the main window.

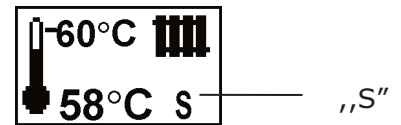

Drawing 18 Signalling time periods

 Decrease in the preset boiler temperature on account of time period is inactive during filling of the DHW tank (when the DHW pump is active).

8.18 Information

The information menu allows to view temperatures and to check which devices are active at the time. Turn the TOUCH and PLAY knob to change the information windows.

 After connecting a mixer extension module MX.01, two additional windows with information about the extra mixers are activated.

The sign „CAL” in the mixer information window, next to the valve opening extent symbol, means active calibration. Wait until the mixer valve servo calibration is completed to see the current percentage of its opening.

8.19 Disabling feeder

Some retort boilers are adapted for burning other types of fuel, e.g. wood rejects, etc. Burning thereof requires the feeder to be off. You can disable the feeder via the regulator; to do so, set the value of the *feeder*

parameter to *off*. The parameter can be found in:

MENU -> FEEDER

After disabling the feeder, the regulator will only control fan and pumps.



Disable the feeder only if the boiler manufacturer provided for such solution. Observe the boiler manufacturer's recommendations.



This option is not intended for boilers with an additional grate, where the air is regulated with a draught regulator or manually by the user. Operation with active fan when an additional grate is present can cause the boiler to overheat.

8.20 Manual control

The regulator provides a possibility of manual activation of an executive device, e.g. a pump, feeder motor, or blower. Thanks to this functionality you can check whether the given device is operative or properly connected.

Manual	
Feeder	OFF
Fan	OFF
CH pump	OFF
DHW pump	OFF
Contact 30-31	OFF
Pump mixer1	OFF
Mixer1 open	OFF
Mixer1 closed	OFF

Drawing 19 View of manual control window



Caution: Enabling a fan, feeder, or another device for a longer period of time can cause danger.

8.21 Restoring user settings

In order to restore default user settings, place the cursor on the „YES“ option and press the “TOUCH and PLAY” knob.

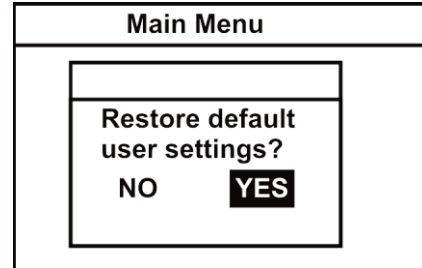

Drawing 20 Default service settings



Only the parameters available in the main menu will be restored to their default settings, the service parameters will remain unaltered.

REGULATOR INSTALLATION AND SERVICE SETTINGS MANUAL

ecoMAX 800, model R1

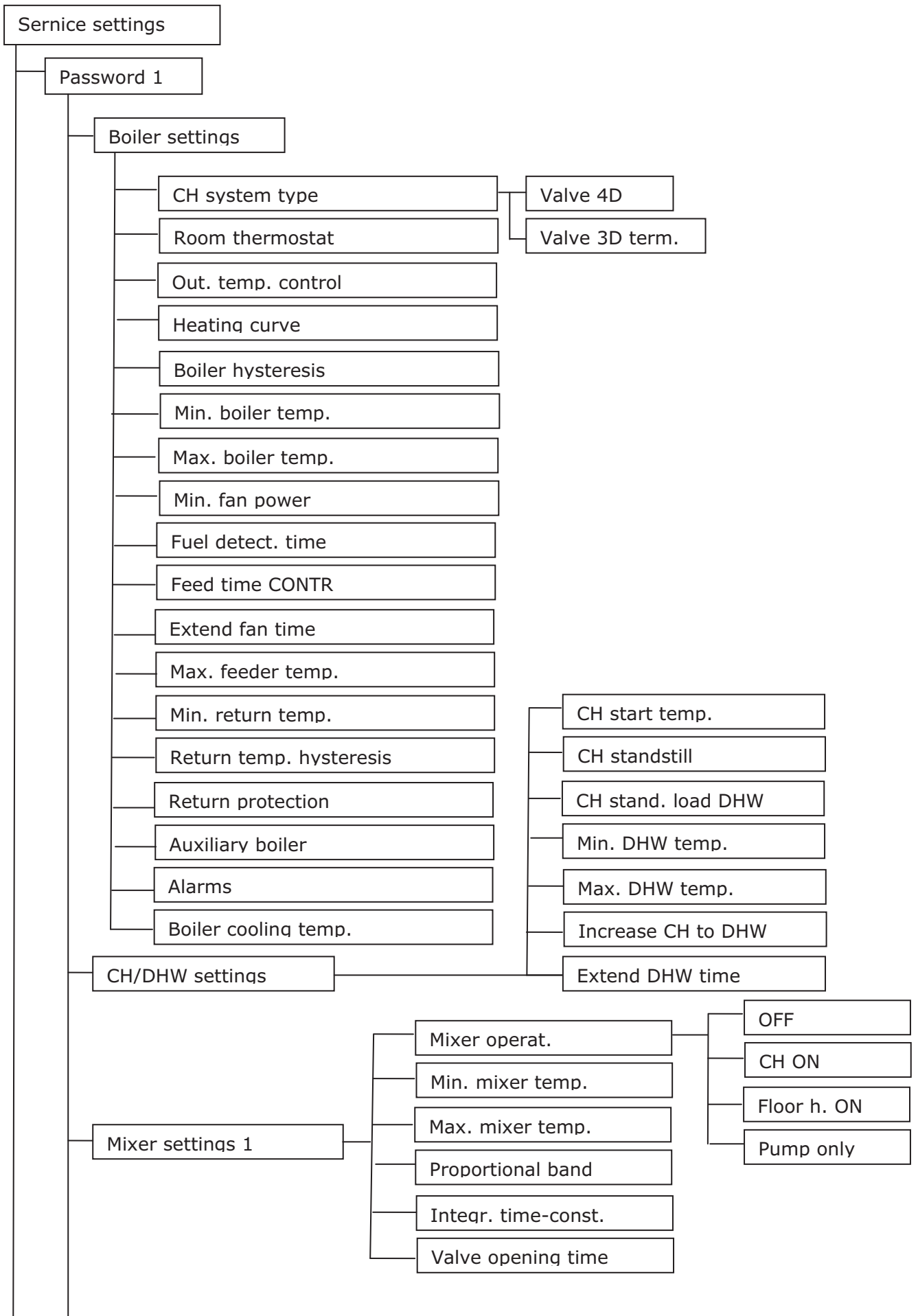

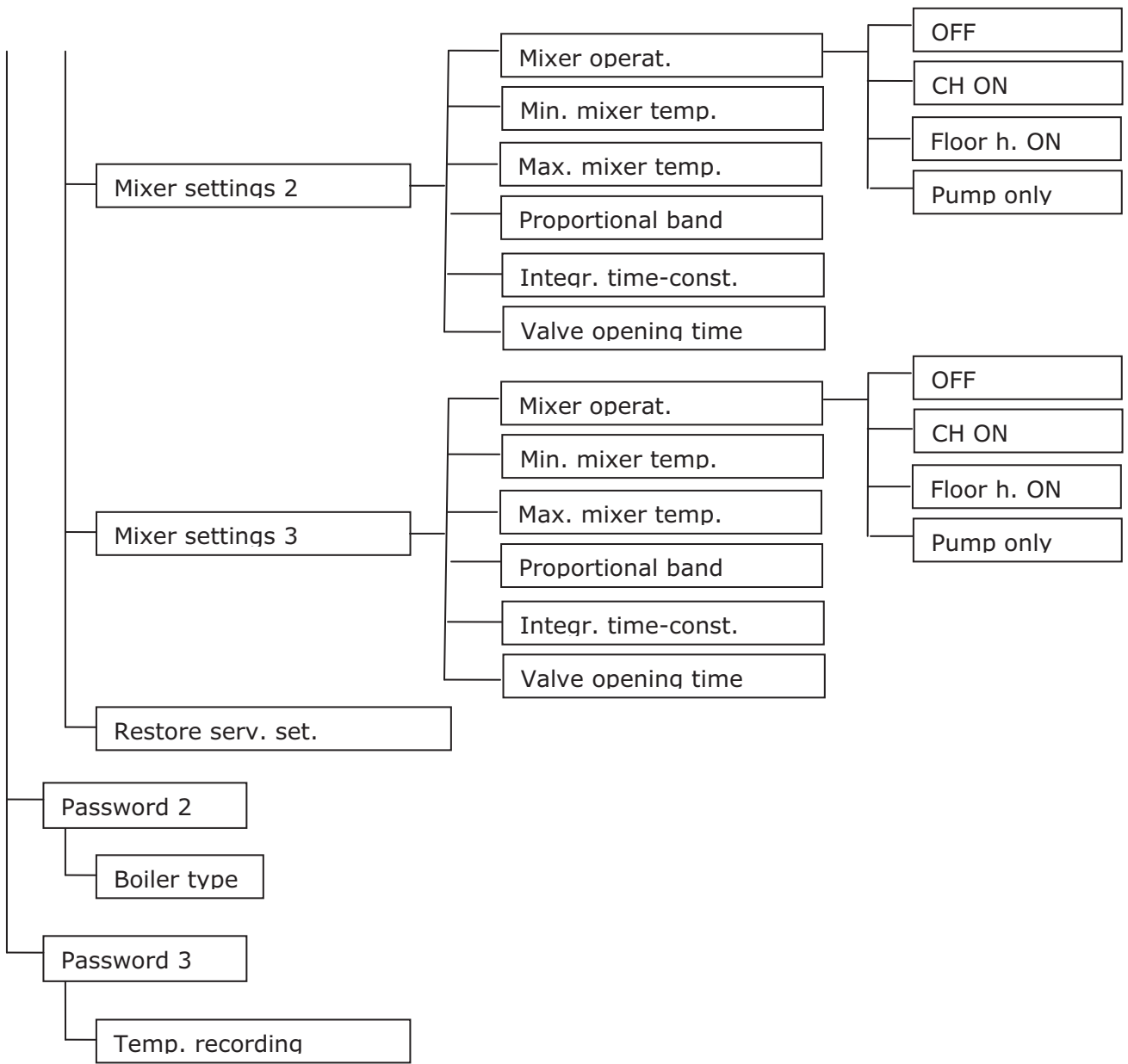

10 Hydraulic diagrams

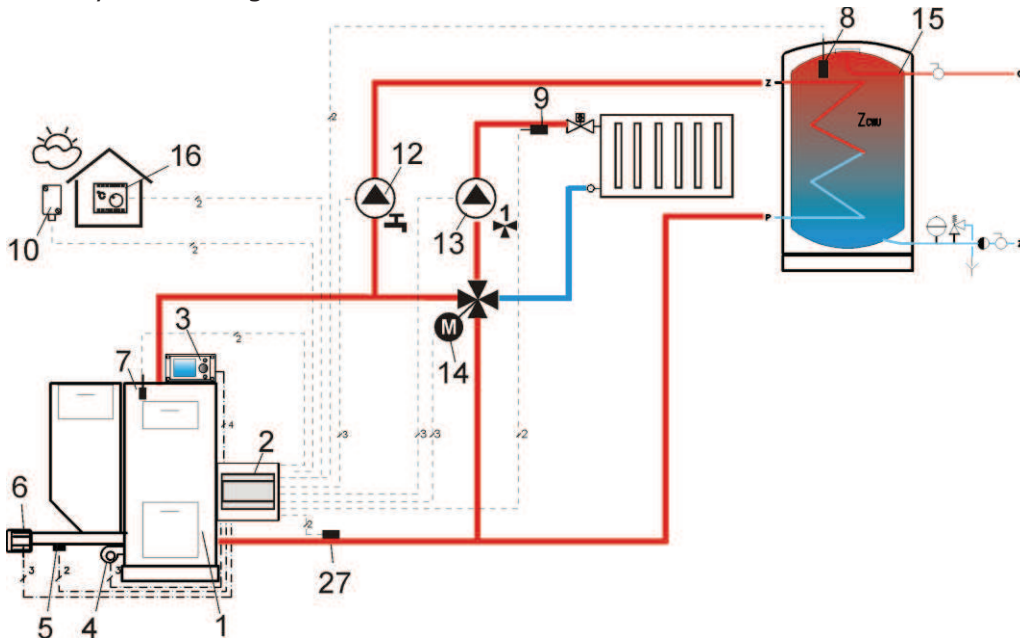

Drawing 21 Diagram with four-way valve controlling the central heating cycle², where: 1- boiler with retort feeder, 2 – ecoMAX regulator – executive module, 3 – ecoMAX regulator – control panel, 4 - Fan, 5 – feeder temperature sensor, 6 – gear motor engine , 7 – boiler temperature sensor, 8 - domestic hot water temperature sensor, 9 – mixer temperature sensor, 10 – temperature sensor – weather, 12 – domestic hot water cycle pump, 13 – mixer cycle pump, 14 – mixer servo, 15 – domestic hot water tank, 16 – room thermostat, 27 – return temperature sensor.

SUGGESTED SETTINGS:

Parameter	Setting	MENU
CH system type	Valve 4D	SERVICE SETTINGS -> BOILER SETTINGS
Min. return temp.	42°C	SERVICE SETTINGS -> BOILER SETTINGS
Mixer operation	CH on	SERVICE SETTINGS -> MIXER 1 SETTINGS
Max. preset mixer temp.	85°C	SERVICE SETTINGS -> MIXER 1 SETTINGS
Min. preset CH temp.	60°C	SERVICE SETTINGS -> BOILER SETTINGS
Mixer out. temp. dep.	on	MENU -> MIXER 1 SETTINGS
Mixer heating curve	0.8 - 1.4	SERVICE SETTINGS -> MIXER 1 SETTINGS
Out. temp. control	off	SERVICE SETTINGS -> BOILER SETTINGS

Brief description: The DHW pump (12) can start its operation only after the boiler exceeds the *CH pump start temp.* (by default 40°C) Mixer pump and servo start operation regardless of the value of the parameter *CH pump start temp.* The mixer servo (14) finds such valve opening stage at which the temperature at sensor (9) will be equal to the *preset mixer temperature.* When the temperature measured by sensor (8) drops below the *preset DHW temperature*, the DHW pump (12) is enabled. The DHW pump (12) will be disabled after the DHW tank (15) is filled, i.e. when the temperature on sensor (8) is equal to the *preset DHW temperature.* When the temperature on sensor (27) drops below the value *Min. return temp.*, the servo (14) closes to the value *close valve for return protect.* After the temperature on sensor (27) increased by the value *Return temp. hyst.*, the servo switches into stabilization of *preset mixer temperature.*

The setting *Mixer operation = CH on* guarantees that even in the case of the boiler (1) overheating, the mixer (14) will open maximally, and the mixer pump (13) will not be disabled at the moment of exceeding the *Max. preset mixer temp.*

Return protection is available only for mixer 1.

² The presented hydraulic diagram does not replace the central heating system design and is provided solely for the purposes of demonstration!

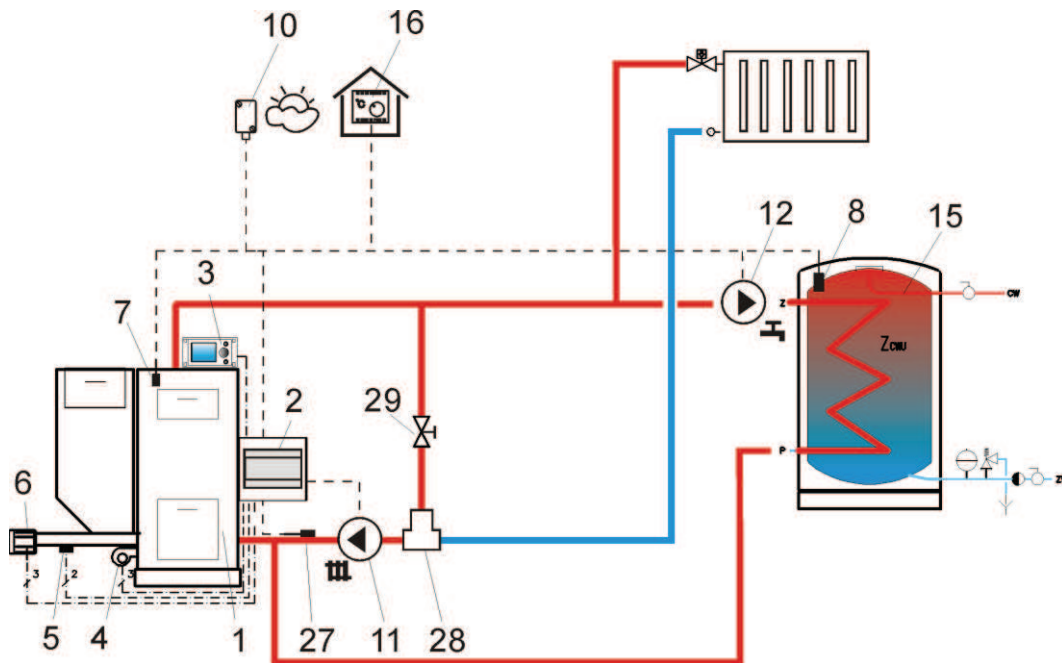

Drawing 22 Diagram with thermostatic three-way valve which protects the temperature of return water³, where: 1- boiler with retort feeder, 2 – ecoMAX regulator – executive module, 3 – ecoMAX regulator – control panel, 4 - Fan, 5 – feeder temperature sensor, 6 – gear motor engine , 7 – boiler temperature sensor, 8 - domestic hot water temperature sensor, 9 – mixer temperature sensor, 10 – temperature sensor – weather, 11 – central heating cycle pump, 12 – domestic hot water cycle pump, 13 – mixer cycle pump, 14 – mixer servo, 15 – domestic hot water tank, 16 – room thermostat, 27 – return temperature sensor, 28 – thermostatic three-way valve 50-55°C, 29 – throttle (poppet) valve.

SUGGESTED SETTINGS:

Parameter	Setting	MENU
CH system type	Valve 3D term.	service settings -> boiler settings
Mixer operation	off	service settings -> mixer 1 settings
Out. temp. control	on	service settings -> boiler settings
Heating curve	1.8 – 4	service settings -> boiler settings

Brief description: The CH pump (11) and the DHW pump (12) can start their operation only after the boiler exceeds the *CH pump start temp.* (by default 40°C). The thermostatic valve (28) closes at the initial stages of heating, when the water getting into the boiler is cold. This causes the boiler water to flow in a short cycle: boiler (1) – throttle valve (29) - thermostatic valve (28) – pump (11). The thermostatic valve (28) opens after the temperature returning to the boiler increases, directing the boiler water to the central heating system. When the temperature measured by sensor (8) drops below the preset DHW temperature, the DHW pump (12) is enabled. The DHW pump (12) will be disabled after the DHW tank (15) is filled, i.e. when the temperature on sensor (8) is equal to the preset DHW temperature.

³ The presented hydraulic diagram does not replace the central heating system design and is provided solely for the purposes of demonstration!

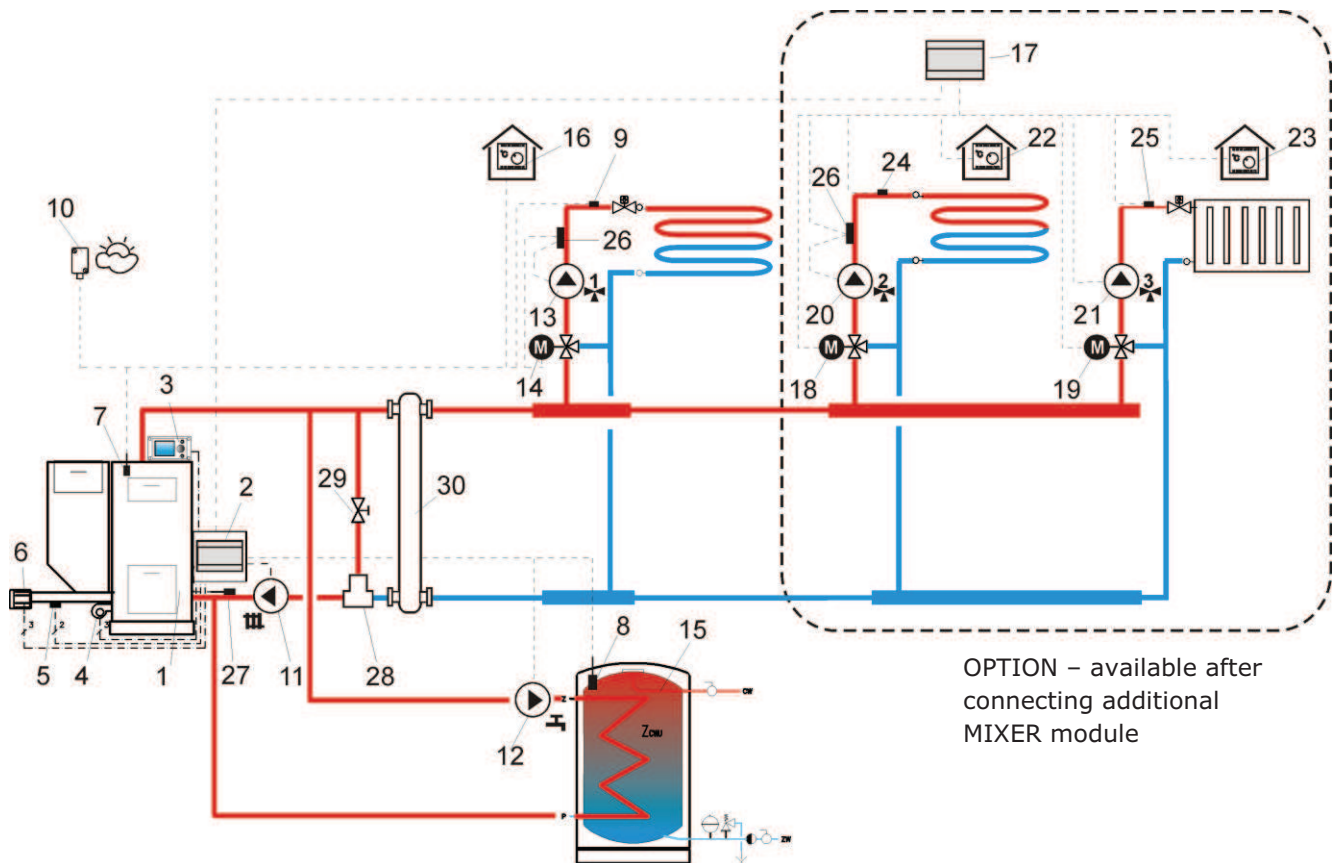

OPTION – available after connecting additional MIXER module

Drawing 23 Diagram with a three-way thermostatic valve which protects the temperature of the return water, and a three-way valve which feeds floor heating, as well as with two additional mixer cycles after attachment of extension module MX.01⁴, where 1 – boiler with retort feeder, 2 - ecoMAX regulator - executive module, 3 - ecoMAX regulator – control panel, 4- Fan, 5 – feeder temperature sensor, 6 – gear motor engine, 7 – boiler temperature sensor. 8 – domestic hot water temperature sensor, 9 – mixer temperature sensor, 10 – temperature sensor—weather, 11 – central heating cycle pump, 12 – domestic hot water cycle pump, 13 – mixer cycle pump, 14 – mixer servo, 15 – domestic hot water tank, 16 – room thermostat, 17 – ecoMAX 800 regulator – mixer module MX.01. 18 – mixer servo 2, 19 – mixer servo 3, 20 – mixer pump 2, 21 – mixer pump 3, 22 room thermostat of mixer 2, 23 – room thermostat of mixer 3, 24 – temperature sensor – mixer 2, 25 – temperature sensor – mixer 3, 26 – external thermostat protecting floor heating 55°C (cuts off power supply of mixer pump when the maximum temperature is exceeded – the thermostat is not part of the ecoMAX 800 regulator set), 27 – return temperature sensor, 28 – thermostatic three-way valve 50-55°C (protecting boiler return), 30 – fluid coupling (eliminates necessity of balancing the pumps’ flows).

SUGGESTED SETTINGS:

Parameter	Setting	MENU
CH system type	Valve 3D term.	service settings -> boiler settings
Mixer operation	Floor h. ON	service settings -> mixer 1 settings
Max. preset mixer temp.	45°C!	service settings -> mixer 1 settings
Mixer heating curve	0.2 – 0.6	service settings -> mixer 1 settings
Mixer operation	Floor h. ON	service settings -> mixer 2 settings
Max. preset mixer temp.	45°C!	service settings -> mixer 2 settings
Mixer heating curve	0.2 – 0.6	service settings -> mixer 2 settings
Mixer operation	CH on	service settings -> mixer 3 settings
Max. preset mixer temp.	85°	service settings -> mixer 3 settings
Mixer heating curve	0.8 – 1.4	service settings -> mixer 3 settings

⁴ The presented hydraulic diagram does not replace the central heating system design and is provided solely for the purposes of demonstration!

11 Technical data

Voltage	230V~; 50Hz;
Current consumed by regulator	$I = 0,02 A^5$
Maximum rated current	6 (6) A
Regulator protection rating	IP20, IP00 ⁶
Ambient temperature	0...50 °C
Storage temperature	0...65°C
Relative humidity	5 - 85% without condensation of vapour
Measuring range of temperature sensors CT4	0...100 °C
Measuring range of temperature sensors CT4-P	-35...40 °C
Accuracy of temperature measurements with sensors	2°C
Terminals	Screw terminal on the mains voltage side 2,5mm ² Screw terminals on the control side 1,5mm ²
Display	Graphic 128x64
External dimensions	Control panel: 164x90x40 mm Executive module: 140x90x65 mm
Total weight	0,5 kg
Norms	PN-EN 60730-2-9 PN-EN 60730-1
Software class	A
Protection class	To be built into class I devices

Table 1 Technical data

The set includes:

- boiler temperature sensor	1 piece
- feeder temperature sensor	1 piece
- DHW temperature sensor,	1 piece
- executive module	1 piece
- control panel	1 piece
- connecting cable	
- panel lid	1 piece
- panel hole plugs	4 pcs.
- panel screws B3x8	2 pcs.

⁵ This is the current consumed by the regulator itself. The total current consumption depends on the devices connected to the regulator.

⁶ IP20 – from the front side of the executive module, IP00 – from the side of terminals of the executive module, detailed information presented in point 13.5

- manual	1 piece
- warranty	1 piece

12 Conditions of storage and transport

The regulator cannot be exposed to direct effects of weather, i.e. rain and sunlight. Storage and transport temperature cannot exceed the range of -15...65 °C.

During transport, the device cannot be exposed to vibrations greater than those typical of normal road transport.

13 REGULATOR INSTALLATION

13.1 Environmental conditions

On account of risk of shock, the regulator has been designed to be used in an environment in which dry conductive pollutants occur (pollution level 3, acc. to PN-EN 60730-1).

Due to the risk of fire, it is prohibited to operate the regulator in explosive gas and flammable dust atmosphere (e.g. coal dust). The regulator should be separated using appropriate enclosure.

Moreover, the regulator cannot be used in the presence of vapour condensation, and be exposed to water.

13.2 Installation requirements

The regulator should be installed by a qualified and authorised fitter, in accordance with the applicable norms and regulations.

The manufacturer bears no responsibility for damages caused by failure to observe this manual.

The regulator is to be built-in. The regulator cannot be used as a stand-alone device.

The temperature of the ambient and the fitting surface cannot exceed the range of 0 - 50°C.

The device has two-module structure which includes control pane and executive module. Both parts are connected with an electric lead.

13.3 Installation of control panel

The control panel is to be enclosed on a mounting plate. Proper thermal insulation between hot boiler walls and the panel and the connecting tape must be provided. The space required for the control panel is shown in Drawing 26 . During installation, follow the guidelines below.

STEP 1

A hole must be made in the mounting plate, in accordance with the drawing below.

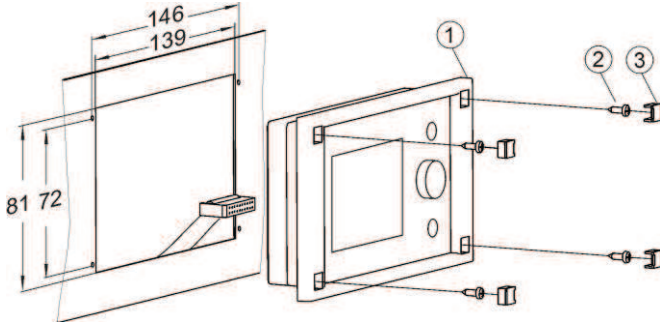

Drawing 24 Fitting the regulator in a mounting plate, where: 1 – control panel, 2 – sheet metal screw 2.9x13, 3 – hole plug.

STEP 2

Remove the lid (5), plug the cable (6) and put the lid (5) back on, securing it with screws (4). The cable should be lead out through the round groove in the enclosure.

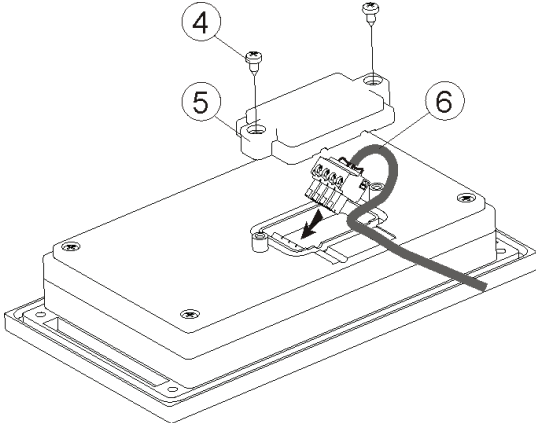

Drawing 25 Connecting lead to the panel, where: 4- B3x6 screw for thermoplastic materials, 5 – lid, 6 – lead connecting the control panel with the executive panel.



Maximum length of the lead (6) is 5m with cross-section of 0,5mm²

STEP 3

Screw the panel to the mounting plate using sheet metal screws (2), insert the hole plugs (3).

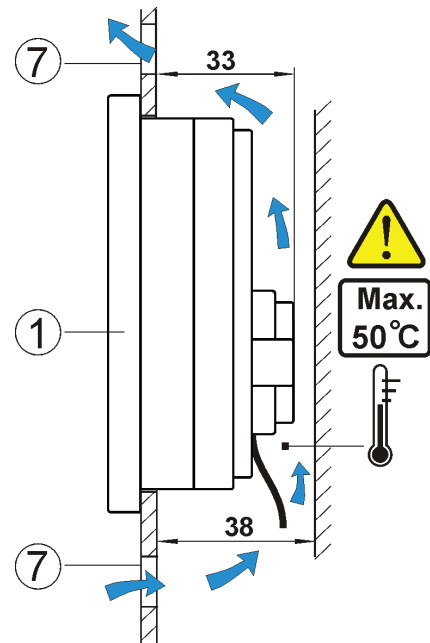

Drawing 26 Conditions of enclosing the panel, where 1 – panel, 7- ventilation holes for air circulation (note: the holes cannot decrease the required IP protection rate; ventilation holes are not required if the limiting temperature of the panel surroundings is not exceeded; the ventilation holes do not always guarantee that the temperature of the panel surroundings will be lowered, in such case use other methods),

13.4 Executive module installation

The enclosure must provide protection rate appropriate for the environmental conditions in which the regulator will be used. Moreover, the enclosure must prevent access to dangerous, live elements, e.g. terminals. The device can be enclosed in a standard, fitting case the width of which is eight modules, as shown in Drawing 29a. In such case, the user has access to the front surface of the executive module. The enclosure can be also constituted by elements of boiler which surround the entire module Drawing 29b. The space required for the executive module is presented in Drawing 28 and Drawing 29. The module casing does not provide resistance to dust and water in order to provide protection against these factors, enclose the module in an appropriate casing. The executive module is designed to be fitted on a standardised bus bar DIN TS35. The bus should be securely fixed to a rigid surface. Before placing the module on the bus (2), lift the taps (3) using a screwdriver, Drawing 27. After placing the module on the bus, push the taps (3) into their original position. Make sure that the device is tightly fixed and it

cannot be removed from the bus without using a tool. Plug in the cable (4) which connects the module with the control panel.

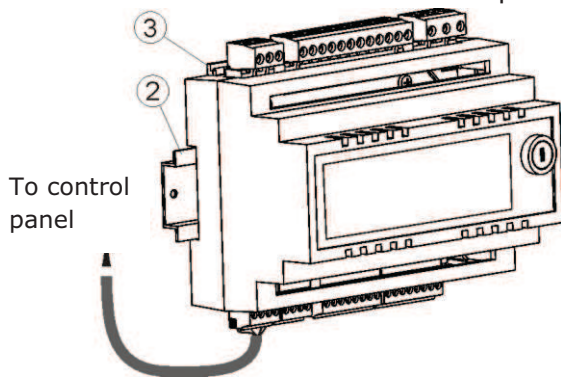

Drawing 27 Mounting regulator on bus, where: 1 – executive module, 2 – bus DIN TS35, 3 – taps.

Due to safety requirements, a safe distance between active parts of the executive module terminals and the conductive (metal) elements of the enclosure must be kept (at least 10mm).

Connecting wires must be protected against being torn out, loosened, or they must be enclosed in a way which prevents any tensions in relation to the wires.

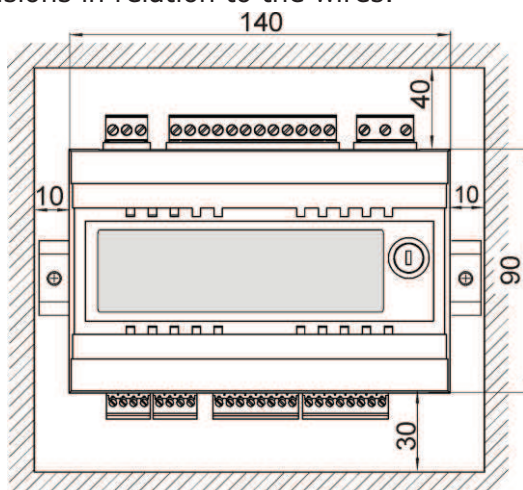

Drawing 28 Conditions of enclosing the module

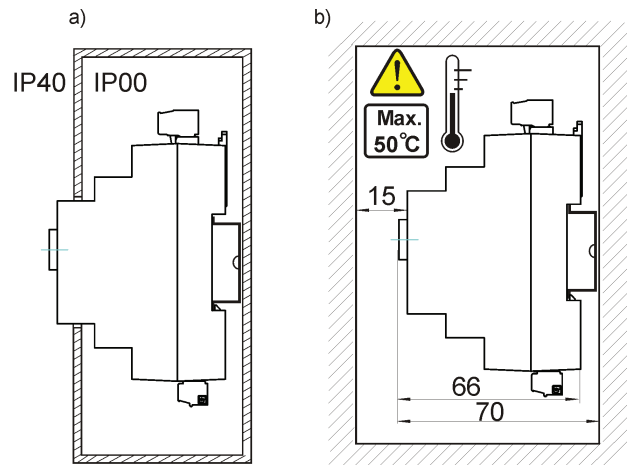

Drawing 29 Methods of enclosing the module: a – in modular enclosure with access to front surface, b – in enclosure without access to the front surface

13.5 IP protection rate

Enclosure of the regulator's executive module provides various IP protection rates, depending on the method of installation. Drawing 29a provides an explanation. After enclosing in accordance with this drawing, the device has protection rate IP 20 from the front side of the executive module enclosure (specified on the rating plate). From the side of the terminals, the casing has protection rate IP00, thus the terminals of the executive module must unconditionally be enclosed, in order to prevent access to this part of the casing.

If it is necessary to access the part with the terminals, disconnect the mains supply, make sure that there is no voltage on terminals and leads, and remove the executive module enclosure.

13.6 Connecting electrical system

Regulator is designed to be fed with 230V~, 50Hz voltage. The electrical system should be:

- three core (with protective wire),
- in accordance with applicable regulations.



Caution: After the regulator is turned off using the keyboard, dangerous voltage can occur on the terminals. Before starting any assembly works, you must disconnect the mains supply and make sure that there is no dangerous voltage on the terminals and the leads.

Diagram of electrical connections is presented in Drawing 31. The connection wires should not have contact with surfaces of room temperature exceeding the nominal temperature of their operation.

Terminals number 1-15 are intended only for connecting devices with mains supply 230V~.

Terminals 16-31 are intended for cooperation with low voltage devices (below 12 V).



Connecting mains supply 230V~ to terminals 16-31 and to transmission connectors RS485 will damage the regulator and creates risk of an electric shock.

Tips of the connected wires, especially power leads, must be secured against splitting by means of insulated clamp sleeves, in accordance with the drawing below:

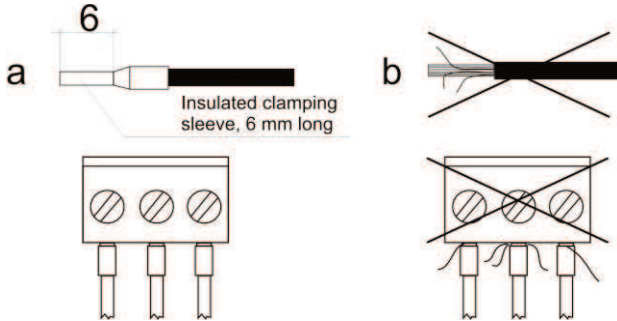

Drawing 30 Securing wire tips: a) right, b) wrong

The feeder cable should be connected to the terminals marked with an arrow.

13.7 Protective connections

The protective conductor of the feeder cable should be connected to a neutral strip contacted with the metal casing of the regulator. The fitting should be connected to the regulator terminal marked with symbol \oplus and with grounding terminals of the devices connected to the regulator (Drawing 31).

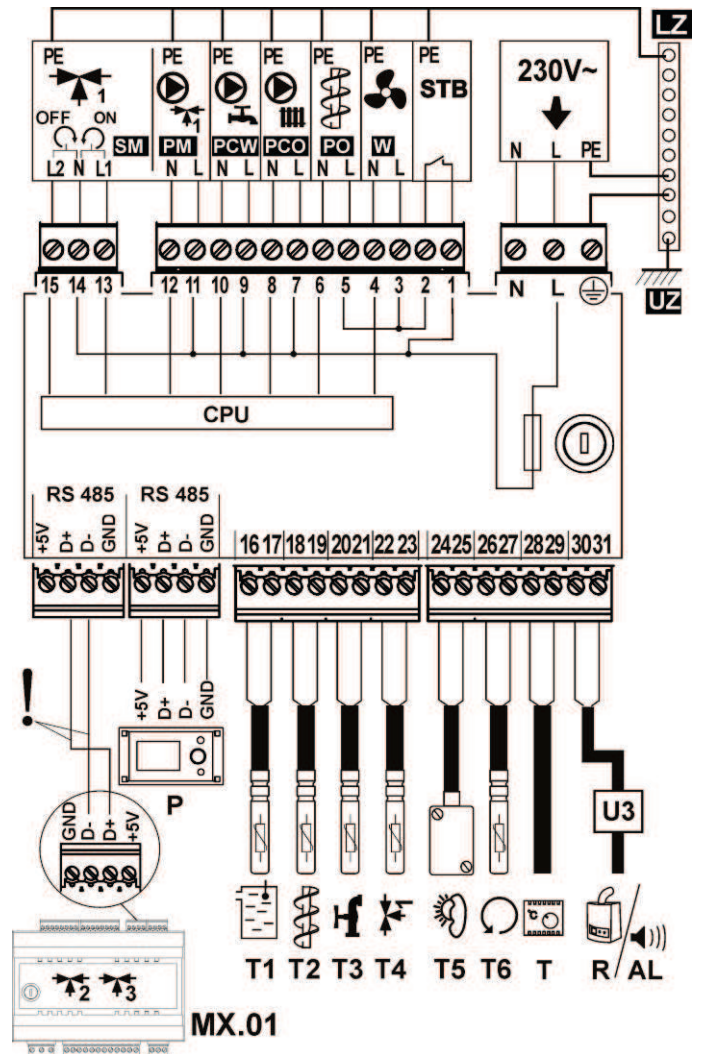

Drawing 31 Diagram of electric connections with external devices, where: T1 – boiler temperature sensor CT4, T2 fuel feeder temperature sensor CT4, T3 – domestic hot water temperature sensor, T4 – mixer 1 temperature sensor, CT4, T5 – weather temperature sensor type CT4-P, T6 – temperature sensor for water returning to the boiler (optional), U3 – relay for connecting reserve boiler or alarm, T – room thermostat, P – boiler control panel, MX.01 – extension module (option, tow additional heating cycles), ! - connect with two wires – do not connect with four wires. 230V~ - feeding cable, STB – safety temperature limiter (disconnects feeder and airflow), W – fan, PO – fuel feeder motor, PCO – central heating pump, PCW – domestic hot water pump, PM – mixer pump, SM – mixer servo, LZ – neutral strip, UZ – earthing of the regulator metal casing.



The regulator must be equipped with a set of pins, inserted in the connectors for feeding 230V~ devices

13.8 Connecting temperature sensors

The regulator cooperates only CT4 sensors. It is forbidden to use different sensors. Sensor leads can be extended with wires with section of at least 0,5mm². Total length of the sensor leads cannot exceed 15 m. The boiler temperature sensor should be fitted in the thermometric pipe, situated in the boiler shell. The feeder temperature sensor must be fitted on the surface of the feeder screw pipe. The domestic hot water temperature sensor - in the thermometric pipe welded into the tank. It is best to fit the mixer temperature sensor in a tube (sleeve) placed in the stream of water flowing in the pipe, but it is also possible to clip it onto the pipe, covering the sensor and the pipe with thermal insulation.



The sensors must be secured against coming loose from the measured surfaces.

Good thermal contact between the sensors and the measured surface must be ensured. For this purpose, use thermally conductive paste. Do not pour oil or water over the sensors.

The sensor cables should be separated from mains leads. Otherwise, the temperature indications can be incorrect. Minimum distance between these leads should be at least 10 cm.

The sensor leads cannot have contact with hot elements of the boiler and heating system. The temperature sensors' leads are resistant to temperature up to 100°C.

13.9 Connecting weather sensor

The regulator cooperates only with a weather sensor of the CT4-P type. The sensor should be installed on the coldest wall of the building, usually this is the northern wall, under a roof. The sensor should not be exposed to direct sunlight and rain. The sensor should be fitted at least 2m above the ground, far from windows, chimneys and other heat sources which could disturb the temperature measurement (at least 1,5 m). Connect the sensor using cable of 0,5 mm² cross-section, up to 25 m long. Bias of the

leads is insignificant. Connect the other end of the cable to the regulator, as shown in Drawing 31.

Attach the sensor to the wall using tackbolts. To access the tackbolts holes, unscrew the sensor lid.

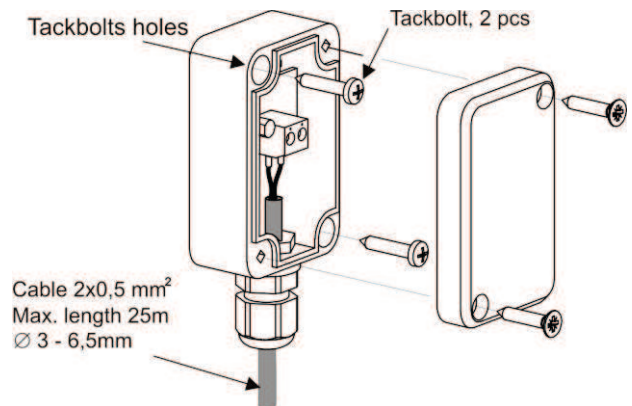

Drawing 32 Connecting weather sensor CT4-P, the sensor is an optional equipment.

13.10 Checking temperature sensors

The CT4 temperature sensor can be controlled by measuring its resistance in a given temperature. In the case of finding significant differences between the value of measured resistance and the values presented in the table below, the sensor must be changed.

CT4			
Ambient temp. °C	Min. Ω	Nom. Ω	Max Ω
0	802	815	828
10	874	886	898
20	950	961	972
25	990	1000	1010
30	1029	1040	1051
40	1108	1122	1136
50	1192	1209	1225
60	1278	1299	1319
70	1369	1392	1416
80	1462	1490	1518
90	1559	1591	1623
100	1659	1696	1733

Table Values of resistance of temperature sensors CT4

CT4-P (weather)			
Temp. °C	Min. Ω	Nom. Ω	Max Ω
-30	609	624	638
-20	669	684	698
-10	733	747	761

0	802	815	828
10	874	886	898
20	950	961	972

Table Values of resistance of temperature sensors CT4-P

13.11 Connecting room thermostat

To make the boiler more economical, and the temperature in the heated rooms more stable, install a room thermostat.

The regulator is compatible with a mechanical or electronic room thermostat, which disconnects its contact after a preset temperature has been reached. The thermostat should be connected in accordance with Drawing 31.

After installing a room thermostat, you must enable its support in:

MENU-> SERVICE SETTINGS -> BOILER SETTINGS -> ROOM THERMOSTAT

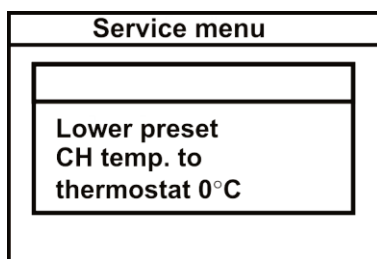

Drawing 33 Setting up the regulator for cooperation with a room thermostat



After reaching the preset temperature in the room, the room thermostat disconnects its contacts, and a letter "T" appears on the display



Drawing 34 View of the main window after activation of thermostat

Setting any value other than „0“ will cause activation of the room thermostat.

When the temperature in the room where the room thermostat is installed reaches the preset value, the regulator will decrease the preset boiler temperature by the value *Lower preset CH temp. to thermostat*. This will cause longer boiler standstills (staying in the

CONTROL mode), thus decreasing the temperature in the heated rooms.

Additionally, in for the purposes of precise adjustment of temperature in the heated rooms, it is possible to enable blockade of the CH pump by disconnection of contactors of the room thermostat. In order to enable the CH pump blockade, enter:

MENU -> SERVICE SETTINGS -> CH/DHW SETTINGS -> CH STANDSTILL

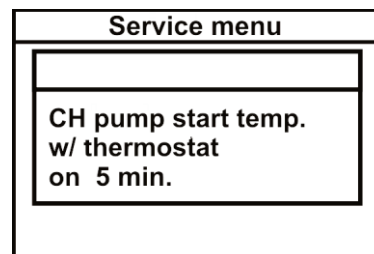

and set the value of this parameter as greater than zero. For instance, setting a value of 5 will cause the pump to be disabled by the room thermostat for 5 minutes. After this time, the regulator will enable the CH pump for a constant, programmed time of 30 s. With this parameter set at „0“, the CH pump will not be blocked by the room thermostat. This solution prevents too extensive cooling of the system due to CH pump blockade.



Central heating pump blockade by thermostat can be enabled only after making sure that the boiler will not overheat.

If the boiler overheats after the thermostat is activated, decrease the value of this parameter or set it to "0".

13.12 Connecting reserve boiler

The regulator can control a reserve boiler (gas- or oil-fired), eliminating the necessity of enabling or disabling this boiler manually. The reserve boiler will be enabled if the temperature of the retort boiler drops, and disabled when the retort boiler reaches an appropriate temperature. Connection to a reserve boiler, e.g. oil-fired one, should only be made by a qualified fitter, in accordance with the technical documentation of this boiler.

The reserve boiler should be connected to terminals 30-31 of the regulator via relays,

as demonstrated in Drawing 31 and Drawing 35.

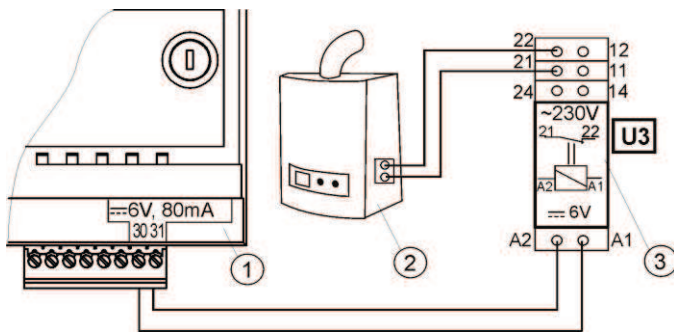

Drawing 35 Model diagram of layout for connecting a reserve boiler to the ecoMAX 800 regulator, where: 1 – ecoMAX 700 regulator, 2 – reserve boiler (gas- or oil-fired), 3 – Module U3, consisting of relay RM 84-2012-35-1006 and base GZT80 RELPOL.

In a standard version, the regulator is not equipped with the U3 module. Components necessary for assembly of the U3 module can be purchased from the manufacturer of the ecoMAX regulator.



You have to perform assembly and installation of the module by yourself, in conformity with the applicable standards.

To enable control of a reserve boiler, set the temperature of the CH system at which the reserve boiler is to be disabled:

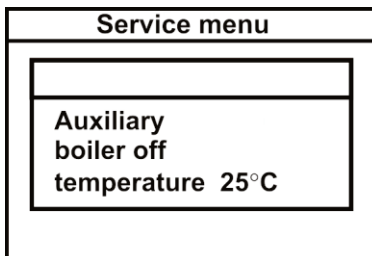

Drawing 36 Enabling control of a reserve boiler

MENU -> SERVICE SETTINGS -> BOILER SETTINGS -> AUXILIARY BOILER -> Auxiliary boiler off temperature

Control over a reserve boiler is disabled if the aforementioned parameter is set to „0“. When the retort boiler is fired up, and its temperature exceeds a preset value, e.g. 25°C, the ecoMAX 800regulator will disable the reserve boiler. It will supply a constant voltage 6V to terminals 31-31. This will cause release of the U3 module relay coil, and its contacts will be disconnected. After the boiler temperature drops below the parameter *auxiliary boiler off temperature*,

the regulator ceases to supply voltage to the terminals 30-31, which will activate the reserve boiler.



Disabling control over reserve boiler causes switching of the contact 30-31 to alarms.



Switching the ecoMAX800 regulator into the STOP or STANDBY modes causes activation of reserve boiler.

Mixer is operative when a reserve boiler is enabled. Thanks to this, if the retort boiler runs out of fuel, the mixer cycle is still fed. It is recommended to switch the ecoMAX regulator into the STOP mode if the retort boiler malfunctions and it is necessary to operate on the reserve boiler. In the STOP mode the mixer is operative.

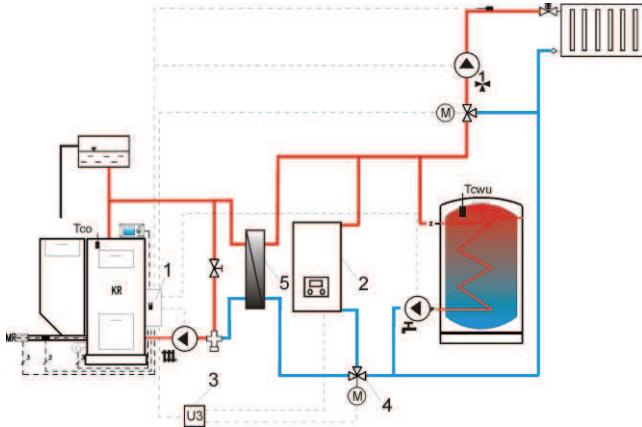

Drawing 37⁸ Hydraulic diagram with a reserve boiler, connection of an open cycle with a closed cycle, where: 1 – ecoMAX regulator, 2 – reserve boiler, 3 - U2 module x 2, 4 – switching valve (with limit switches), 5 – heat exchanger, recommended setting *DHW priority = off*.

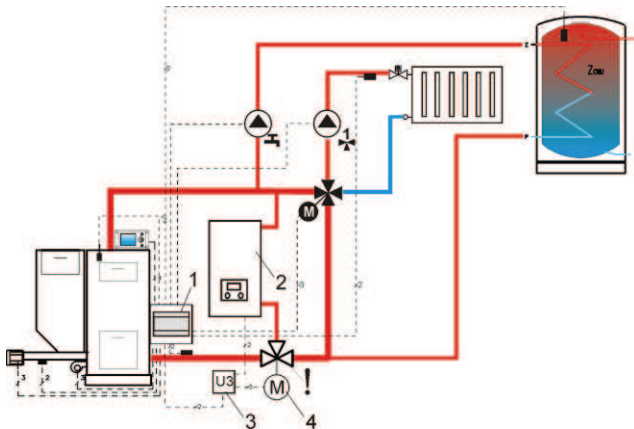

Drawing 38⁷. Hydraulic diagram with reserve boiler and four-way valve in a closed cycle, where: 1 – ecoMAX regulator, 2 – reserve boiler, 3 - U2 module x 2, 4 – servo of switching valve (with limit switches), ! - in order to provide free gravitational flow of water in the boiler cycle, the effective diameter of the switching valve (4) must be greater or equal to the diameter of the boiler cycle pipe.

⁷ The presented hydraulic diagrams do not replace the central heating system design and are provided solely for the purposes of demonstration!

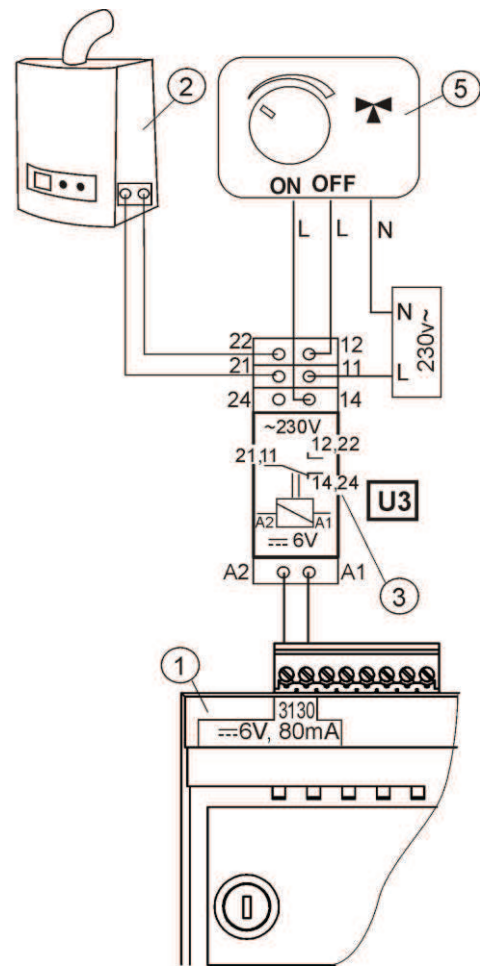

Drawing 39 Electric diagram of switching valve control, where: 1 – ecoMAX regulator, 2 – reserve boiler, 3 – relay, e.g. RM 84-2012-35-1006 RELPOL (U3 module), 5 – servo of switching valve (with limit switches), note: contacts 22, 21, 24 must have galvanic separation from contacts 12, 11, 14.

13.13 Connection of alarm signalling

The regulator can signal emergencies by activating an external device, e.g. a bell or a GSM device which sends short messages (SMS). Alarm signalling and control over a reserve boiler are made using the same contacts, thus enabling alarm signalling precludes control over a reserve boiler. An alarm-signalling device should be connected in accordance with Drawing 40 via a U3 module.

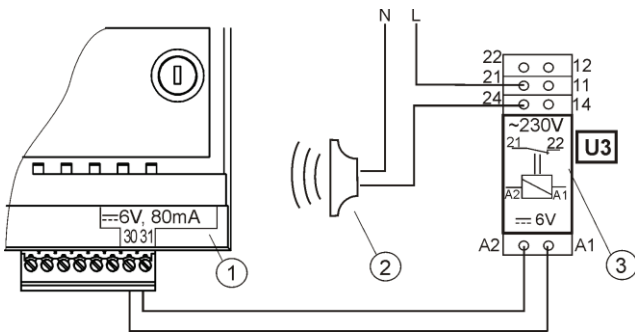

Drawing 40 Connecting an external alarming device, where: 1 – ecoMAX800 regulator, 2 – external alarming device, 3 – U3 Module, consisting of relay RM 84-2012-35-1006 RELPOL and base GZT80 RELPOL.

If the regulator is to control an external alarming device, you must set the parameter *auxiliary boiler off temperature* to "0"



MENU -> SERVICE SETTINGS ->
BOILER SETTINGS -> AUXILIARY
BOILER -> *Auxiliary boiler off
temperature*

To guarantee proper operation, set an appropriate value of the parameter *Active alarms signalling code* in:

MENU -> SERVICE SETTINGS -> BOILER
SETTINGS -> ALARMS -> *Active alarms
signal code*

Choosing a value of 31 causes voltage to be fed to contact 30-31 if any alarm occurs. After setting this parameter to „0“, the regulator will not supply voltage in the case of any alarm.

The 30-31 contact can be configured so that voltage was supplied there only if one or more alarms occur. The value to which this parameter should be set for individual alarms is presented in the following table:

No fuel	Boiler overheated	Flame reversed	CH boiler temperature sensor damage	Feeder temperature sensor damage
AL 1	AL 2	AL 3	AL 4	AL 5
1	2	4	8	16

Example: if you set the value of the parameter to „8“, the voltage will be supplied to the contact only if alarm AL4 occurs. Setting "1" will cause the contact to signalize only alarm "1". Should the contact signalize several alarms, e.g. AL2 and AL4, sum up the values corresponding to individual alarms, i.e. you should set $2 + 8 = 10$. If alarms AL1, AL2 and AL3 are to be signalled, set the parameter to "7", as $1 + 2 + 4 = 7$.

13.14 Connecting mixer

The regulator cooperates only with servos of mixing valves equipped with limit switches. It is prohibited to use different servos. Permitted servos are those which make a full revolution in 30 - 255 s.

Description of connecting a mixer:

- disable power supply to the regulator,
- determine the direction in which the servo opens/closes and make an electric connection between the mixer and the regulator, in accordance with Drawing 31, and with the documentation provided by the valve servo manufacturer (do not confuse the valve direction of opening with the direction of closing). 0
- connect mixer temperature sensor and mixer pump.
- turn the regulator on and set an appropriate *valve full opening time* in the mixer service settings, in accordance with the servo manual.
- disable and enable power supply to the regulator, wait until the servo is calibrated. During the calibration, the servo is closed by the *valve full opening time*. Calibration is signalled in the MENU Information – mixer info by sign "CAL".
- make sure that the servo opens in the correct direction. To do so, open MENU Information and go to tab info-mixer, or enter the regulator manual control. If the mixer does not open in the correct direction, change the electric connection.
- disable and enable power supply to the regulator, wait until the servo is calibrated.
- set the mixer parameters in accordance with point 16.

13.15 Connecting temperature limiter

In order to prevent the boiler from overheating due to the regulator malfunction, an STB safety temperature limiter, or any other appropriate for the given boiler and heating system, should be fitted.

The STB limiter can be connected to terminals 1-2, as specified in Drawing 31. When the limiter is activated, the airflow and fuel feeder motor are disconnected.



The temperature limiter must have nominal operating voltage of at least ~230V, and it should have the applicable permits.

If the limiter is not connected to terminals 1-2, a bridge should be made. The bridge should be made of wire the section of which is at least 0,75 mm², with insulation thick enough to comply with the boiler safety requirements.



The current regulations demand that a safety temperature limiter is used.

13.16 Connecting additional panel

It is possible to connect an additional control panel, situated in the living quarters, e.g. in a kitchen. The additional panel is not supplied as standard. When making the electric connection, observe the following requirement: only one panel can be connected to one executive module of the regulator. If an additional mixer module is not connected to the regulator, it is necessary to apply an extra power adaptor :

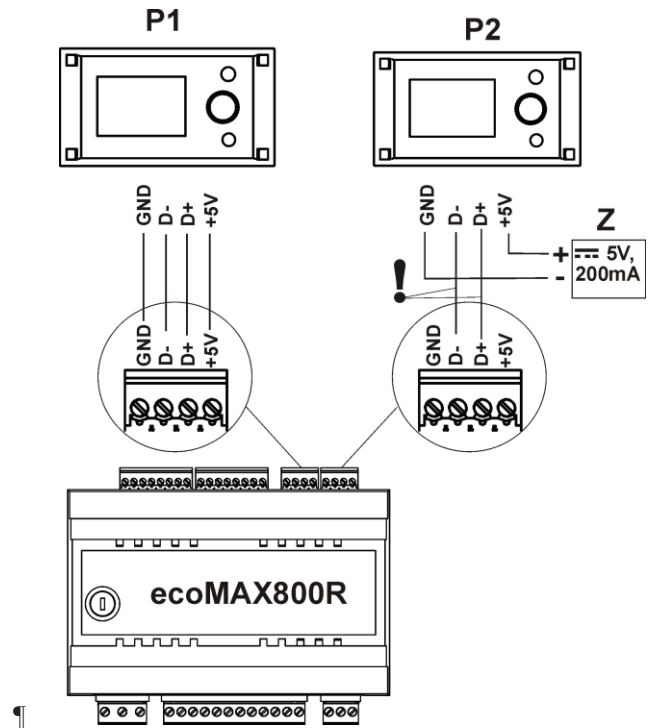

Drawing 41 Connecting an additional module without a mixer module MX.01 connected, where: P1 – boiler panel, P2 – panel in living quarters, Z – power adaptor, ! - connect with two wires.

If an extension module MX.01 is connected to the regulator, it is not necessary to use an extra power adaptor:

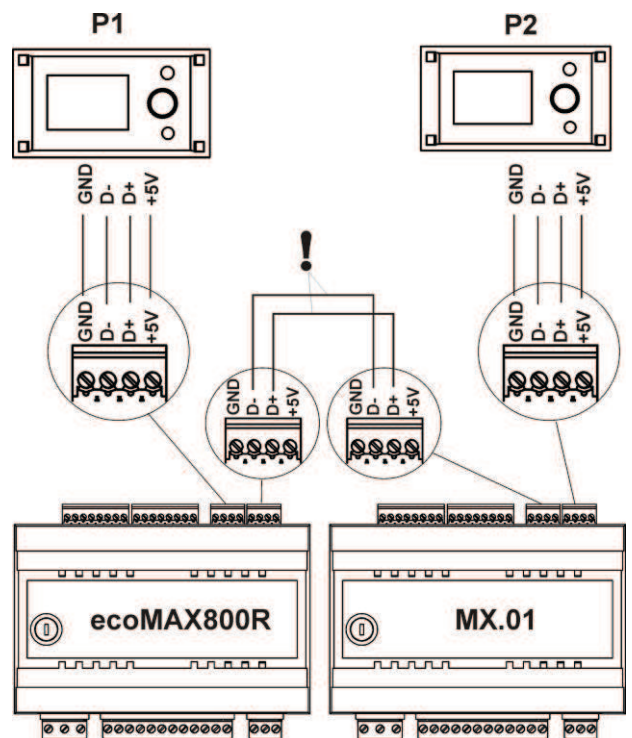

Drawing 42 Connecting an additional module with a mixer module MX.01 connected, where: P1 – boiler panel, P2 – panel in living quarters, MX.01 extension module for two mixer heating cycles, ! - connect with two wires.

Maximum length of leads to the additional power cannot exceed 30m, and their cross section should be at least 0,5 mm².

14 BOILER SERVICE SETTINGS

14.1 Installation type

If the boiler cooperates with a four-way valve and valve servo, and a return temperature sensor is connected, you can activate a function of safeguard against cold water returning to the boiler. To do so, select the option „Valve 4D“. Otherwise, or if the boiler return is safeguarded by a thermostatic valve, choose the option “Valve 3D therm.” Then, the regulator does not influence the safeguards of the boiler return.

Caution: the return protection function is active only for mixer 1 cycle.

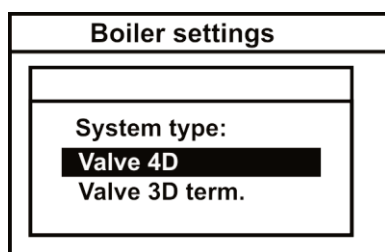

Drawing 43 Installation type

Description of the regulator’s operation in return protection can be found in point 9.



If the return temperature sensor T6 is disconnected or damaged, the regulator will automatically switch into the option *Valve 3D therm.*

14.2 Room thermostat of the boiler

This parameter allows to determine decrease in the preset boiler temperature due to disconnection of room thermostat contacts. Detailed information can be found in point 13.11

14.3 Boiler weather control

This parameter allows to disable weather control of the boiler which calculated the preset boiler temperature on the basis of a weather sensor’s indications. Detailed information can be found in point 8.16 and 13.9.

14.4 Heating curve

This parameters allows selection of appropriate heating curve. Detailed information can be found in point 8.16.

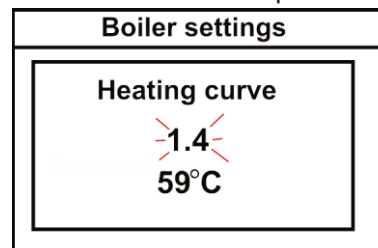

Drawing 44 Selection of the boiler’s heating curve, where: 1.4 – selected heating curve, 59 – temperature calculated from the heating curve for the current outdoor temperature measured by the CT4-P sensor.

14.5 Boiler hysteresis

This parameter determines the temperature at which the boiler returns from the CONTROL mode to the OPERATION mode. The regulator returns to the OPERATION mode at the temperature *preset CH temperature – boiler hysteresis.*

14.6 Minimum preset boiler temperature

This parameter can be used to prevent the user from setting too low preset boiler temperature. If the boiler operates at too low temperature, it can cause its rapid damage, corrosion, soiling, etc. Additionally, the regulator will accept this temperature instead of the preset boiler temperature which results from decreases on account of time periods, or room thermostat.



Set the value in accordance with the boiler manufacturer’s recommendations

14.7 Maximum preset boiler temperature

This parameter can be used to prevent the user from setting too high preset boiler temperature.

If the heating curve temperature or the preset DHW temperature are higher than the *Max. preset CH temp.*, the regulator will adopt the *Max. preset CH temp.* as the preset temperature.



Set the value in accordance with the boiler manufacturer’s recommendations

14.8 Minimum fan power

When the regulator is turned on for the first time, it is necessary to set the user-defined parameter Minimum fan power.

MENU -> SERVICE SETTINGS -> BOILER SETTINGS -> MIN. FAN POWER

This parameter prevents the fan against being damaged due to too low rotary speed. The minimum fan power should be determined after observing the fan behaviour.

After setting a value of e.g. 20%, the user will be able to set fan power of at least 20%.

In the STANDARD regulation mode, before reaching the CH boiler temperature (at temperature $T_{zk} - 1^{\circ}\text{C}$), the regulator starts reducing the fan revolutions, from the value of the parameter *Fan power* to revolutions set by the parameter *Min. fan power*.



If the boiler cannot reach the preset temperature due to reducing the fan revolutions, the value of the parameter *Min. fan power* should be increased.

14.9 Fuel shortage detection time

This is the time after which the regulator starts the fuel shortage detection procedure. This procedure is described in point 18.1.



If the regulator produces the "No fuel" alarm too fast, increase the value of this parameter.

14.10 Feed time CONTROL

This is the time for which the fuel is fed and the airflow is active in the CONTROL mode(Drawing 13).



The value of this parameter cannot be too high, as it can make the boiler overheat in the CONTROL mode. In the CONTROL mode, the boiler temperature must slowly decrease.

14.11 Extending airflow operation

In the CONTROL mode, after feeding a dose of fuel and disabling the feeder, the fan

continues to work for the time of *extend fan time* in order to light up the supplied fuel (in accordance with Drawing 13).



The value of this parameter cannot be too high, as it can make the boiler overheat in the CONTROL mode. In the CONTROL mode, the boiler temperature must slowly decrease.

14.12 Maximum feeder temperature

This is the temperature at which the function which prevents the flame from going back to the fuel feeder is activated. This function is described in point 18.3.



Setting the *max. feeder temp.* to „0" allows to disconnect the feeder sensor and lets the regulator operate without this fuel. Nonetheless, such settings are not recommended, as they will disable the function of preventing flame recession.

14.13 Min. return temperature

This parameter specifies the temperature of water which returns to the boiler, below which the servo of the four-way valve will be closed. After the temperature goes back above this parameter + *return temp. hysteresis*, the servo resumes normal operation.

14.14 Return temperature hysteresis

This parameter specifies the return temperature hysteresis.

14.15 Return protection

This parameter specifies the percentage of closing the four-way valve after the temperature of the water returning to the boiler drops below the specified value. Set such degree of closing at which the boiler return temperature increases the fastest.

14.16 Reserve boiler

Use this parameter to specify the temperature of the retort boiler at which a reserve boiler (e.g. a gas-fired one) is turned

off. Detailed information can be found in point 13.12.

14.17 Alarms – signalling setup

Detailed information can be found in point 13.13

14.18 Boiler cooling temperature

The temperature at which the boiler is preventatively cooled down. Detailed description can be found in point 19.3.



It is suggested to set the *boiler cooling temp.* below the value of activating the safety temperature limiter, which will prevent interruptions in the boiler work due to overheating.

15 CH and DHW SERVICE SETTINGS

15.1 CH start temperature

This parameter specifies the temperature at which the central heating pump is activated. After reaching the temperature equal to the *CH start temp.* parameter, the central heating pump is activated. This protects the boiler against retting caused by its being cooled down by hot water returning from the system.



Disabling the CH pump on its own does not guarantee protecting the boiler against retting, and the resulting corrosion of the boiler. Use additional automatics, e.g. a four-way valve.

15.2 CH pump standstill time

This parameter determines the central heating pump down-time after it is blocked by disconnected room thermostat, at the moment of reaching preset room temperature (point 13.11). As a result of blocking the central heating pump, the temperature in the heated rooms will drop, and the boiler will reach the preset temperature faster, and then switch to the CONTROL mode. Yet, too long a blockade of the central heating pump will cause the system to cool down, which is disadvantageous for maintaining the room temperature at constant level. The heating medium accumulated in the system has high

thermal inertia, and heating it after the thermostat contacts are shorted can take too long. Thus, it is not recommended to set excessively long central heating pump down-times. After the *CH standstill time*, the regulator will enable it for a constant, pre-programmed time of 30 s. Caution: Blocking the CH pump can make the boiler overheat.

15.3 CH pump standstill with DHW priority

Prolonged filling of the DHW tank when DHW priority is enabled can cause extensive cooldown of the CH system, as, with these settings, the CH pump is disabled.

The parameter *CH stand. load DHW* prevents this by enabling periodical activation of the CH pump while the DHW tank is being filled. After this time, the CH pump will be activated for a constant, programmed time of 30s.

15.4 Maximum DHW temperature

This parameter specifies to what maximum temperature will the DHW tank be heated in the case of dropping excessive heat from the boiler during an emergency. This parameter is very important, as setting it at too high a value can scald the users. Too low a value of this parameter will make it impossible to channel excessive heat to the DHW tank if the boiler overheats.

When designing the domestic hot water system, the possibility of regulator malfunction should be taken into consideration. As a result of malfunction of the regulator, the water in the DHW tank can become dangerously hot, threatening the users with scalding.



THEREFORE, ADDITIONAL SAFEGUARDS - THERMOSTATIC VALVES - SHOULD BE USED.

15.5 DHW tank hysteresis

Below the *preset DHW temp. – DHW cont. hysteresis* the DHW pump is activated in order to fill the DHW tank.



After setting a low value, the DHW pump will be activated faster after the DHW temperature drops.

15.6 Increase in boiler temperature an account of DHW and Mixer

This parameter specifies by how many degrees will the preset CH temperature be increased in order to fill the DHW tank and the mixer cycle. Yet, this action will be performed only when such need arises. When the preset boiler temperature is high enough, the regulator will not change it for the purposes of filling the domestic hot water tank or the mixer cycle.



Increasing the preset boiler temperature for the time of filling the domestic hot water tank is signalled by letter „C” in the main display window

15.7 Extending DHW pump

After filling the DHW tank and disabling the DHW pump, there is often a problem of the boiler overheating. It occurs if the preset domestic hot water temperature is higher than the preset boiler temperature. In particular, this problem occurs in the DHW pump mode: SUMMER, when the CH pump is disabled. In order to cool the boiler down, operation of the DHW pump can be extended by the time of *Extend DHW time*.



It is not recommended to set the time of *Extend DHW time* to a value different than zero if the preset DHW temperature is higher than the preset boiler temperature.

16 MIXER SERVICE SETTINGS

16.1 MIXER OPERATION

The following options are available:

OFF – mixer servo and mixer pump are inoperative

CH ON - choose this option if the mixer cycle feeds radiator system of central heating. The maximum temperature of mixer cycle is unlimited, the mixer is fully opened during alarms, e.g. boiler overheat. Caution: Do not enable this option if the system is made of

pipes vulnerable to high temperature; in such case, we recommend setting the mixer to *FLOOR h.ON*.

FLOOR h.ON - choose this option if the mixer cycle feeds a floor system. The maximum temperature of the mixer cycle is limited to the parameter *max. mixer temp.*

Caution: after choosing the option *on FLOOR*, set the parameter *max. mixer temp.* to such value that the floor would not be damaged, and the floor heating users would not be burned.

Pump only – if the servo is damaged, you can enable control of only the mixer pump. In this case, the head of the mixer valve must be adjusted manually. At the moment of exceeding the *max. mixer temp.*, the mixer pumps are disabled, and after the temperature drops – they are enabled again.

16.2 Max. preset mixer temperature

This parameter serves two purposes:

- This parameter can be used to prevent the user from setting too high preset mixer temperature. Additionally, the regulator will adopt this temperature instead of the preset temperature resulting from weather control, if it is higher than *max. mixer temp.*

- if the parameter *mixer operation = FLOOR h.ON* is enabled, it is additionally the limit temperature of the mixer, at which the mixer pump is disabled.



For floor heating, set the value within the range of 45°C - 50°C, unless the manufacturer of the floor materials or the designer of the CH system specified otherwise.

16.3 MIN. preset mixer temperature

This parameter can be used to prevent the user from setting too low preset mixer temperature.

If the mixer preset temperature (e.g. as a result of night-time decreases) is lower than the value *Min. preset mixer temp.*, the regulator will assume the *Min. preset mixer temp.* as the preset temperature.

16.4 Range of proportionality

Caution: it is recommended not to modify this parameter.

This is the mixer step value. Increasing its value will speed up reaching of the preset mixer temperature, yet too high a value of this parameter will cause over-regulation of temperature and unnecessary movement of the servo, thus shortening its life-span. It is recommended to set this parameter within the range of 2 – 6 [by default: 3].

16.5 Integration time constant

Caution: it is recommended not to modify this parameter.

This parameter influences the mixer standstill time if the temperature measured by the mixer sensor is close to the preset mixer temperature. Greater value will cause longer standstills of the servo. Too high a value extends the time by which the servo can find the preset temperature. Setting too low values can cause over-regulation of temperature and faster wear of the servo. It is recommended to set this parameter within the range of 80 – 140 [by default: 110].

16.6 Valve opening time

Enter the time of full valve opening, which can be found in the valve servo documentation.

16.7 Increase in boiler temperature on account of MIXER

If the preset boiler temperature is lower than the preset mixer temperature, the regulator shall automatically assume the preset boiler temperature equal to the preset mixer temperature plus value of the parameter *increase preset CH temp. to DHW*.

This parameter can be found in MENU -> SERVICE SETTINGS -> CH/DHW SETTINGS

17 RESTORING SERVICE SETTINGS

In order to restore default service settings, place the cursor on the „YES“ option and press the “TOUCH and PLAY” knob.

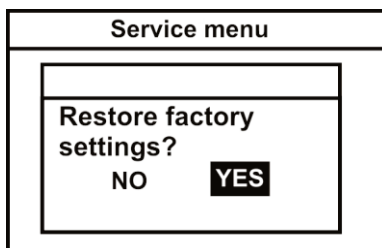

Drawing 45 Default service settings



Restoration of the factory settings will also restore user settings.

18 DESCRIPTION OF ALARMS

18.1 No fuel

If the boiler temperature in the OPERATION mode drops by 10°C below the preset boiler temperature, the regulator will start counting the *no fuel detection time*.

MENU -> SERVICE SETTINGS -> BOILER SETTINGS -> *no fuel detection time*

If during that countdown there is no increase in the boiler temperature by 1 °C, the regulator will disable the CH and DHW pump and will start counting the *no fuel detection time*. This protects the boiler against excessive cool down. If after that time the temperature does not increase by 4°C, the regulator will enter the STOP mode and show the "No fuel" alarm on the display. If the boiler temperature approximates the preset boiler temperature (difference $t \leq 10^\circ\text{C}$), the pumps are activated and countdown of the *no fuel detection time* is stopped. Cancel by restarting the regulator.

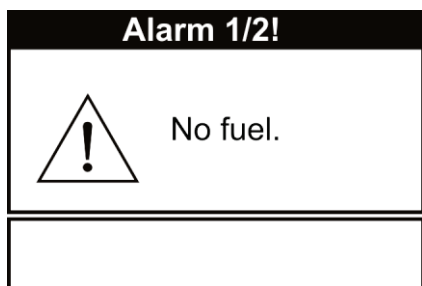

Drawing 46 View of the „No fuel” alarm

If the regulator identifies fuel shortage incorrectly, increase the parameter *no fuel detection time* point 14.9, or decrease the difference between the measured boiler temperature and *preset CH temp.*



In the upper section of the screen, you can see the number of alarms occurring at the same time. Sign 1/2 means that there were two alarms, and the first of them is visible, etc. Move to the next alarm by turning the "TOUCH and PLAY" knob.



18.2 Exceeding max. boiler temperature

Protection against boiler overheating is twofold. First, after exceeding the *boiler cooling preventive temp.* (by default 90°C), the regulator tries to decrease the boiler temperature by dropping the excessive heat to the DHW tank and by opening the mixer servo (only if mixer cycle = on CH). If the boiler temperature drops, the regulator will resume normal operation. Whereas is the temperature continues to rise (reaches 95°C), fuel feeder and fan are disabled and a permanent boiler overheating alarm – with sound signalling – is activated. If during the boiler overheating alarm the temperature measured by the DHW sensor (8) exceeds the value *Max. DHW temp.*, the DHW pump is disabled. This protects the DHW users against scalding. Whereas the mixer pump is not disabled at the moment of exceeding the *Max. preset mixer temperature*, if *mixer operation = CO ON* was set. The mixer pump is disabled at the moment of exceeding the *Max. preset mixer temperature*, if *mixer operation = FLOOR h.ON* was set.

Cancel the alarm by restarting the regulator.



Caution: placing the temperature sensor beyond the boiler water jacket, e.g. on the outlet pipe, is not recommended, as it can delay detection of the boiler overheating.

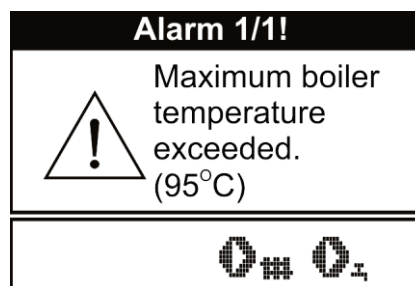

Drawing 47 View of alarm „max. boiler temperature overheating”

18.3 Exceeding max. feeder temperature

This alarm will occur after the feeder temperature exceeds the service parameter *Max. feeder temp.*

MENU -> SERVICE SETTINGS -> BOILER SETTINGS -> *Max. feeder temp.*

If the feeder temperature exceeds this value, the regulator will enable the feeder for a constant, programmed time of 10 minutes.

After this time, the airflow is disabled and the pumps are enabled. After „pushing the fuel out“, the regulator disables the feeder and does not activate it again, even if the feeder temperature is still high.

You can cancel the alarm only after the feeder temperature drops and the regulator is turned off.



The function of protection against flame recession is inoperative if the feeder sensor is disconnected or damaged.



The function of protection against flame recession is inoperative if the regulator is not powered.



The ecoMAX 700R regulator cannot be used as the only protection against flame recession in a boiler. Use additional protective automatics.



The function of protection against flame recession can be disabled, see point 14.12

18.4 Damage to boiler temp. sensor

This alarm will be produced in the case of damage to the boiler sensor, and after exceeding its measuring range. The alarm activates the CH and DHW pumps, as well as the mixer pump, in order to cool the boiler down.

Cancel the alarm by pressing the TOUCH and PLAY button, or by restarting the regulator. Check the sensor, and possibly replace it.



The method of checking the temperature sensor is described in point 13.10

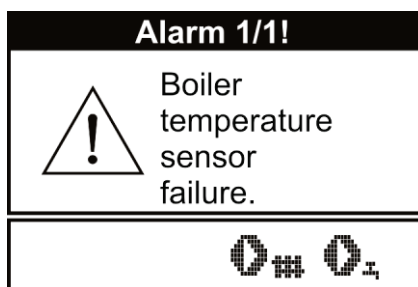

Drawing 48 View of alarm "boiler temperature sensor failure"

18.5 Feeder temperature sensor damage

This alarm will be produced in the case of damage to the feeder sensor, and after exceeding its measuring range. The alarm causes activation of the CH and DHW pumps in order to cool the boiler down.

Cancel the alarm by pressing the TOUCH and PLAY button, or by restarting the regulator. Check the sensor, and possibly replace it.



The method of checking the temperature sensor is described in point 13.10

The regulator can operate if the feeder temp. sensor is disconnected, after setting the parameter *max. feeder temp.* = 0. Nonetheless, it is not recommended, as in this case the function of protection against the flame recession into the fuel hopper is disabled.

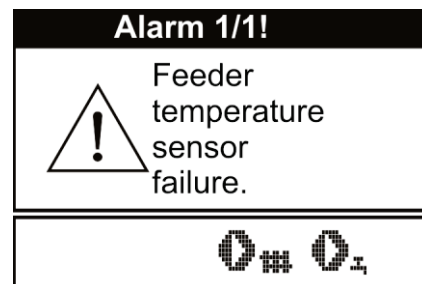

Drawing 49 View of alarm „feeder sensor failure“

18.6 No communication

The control panel is connected with the executive module via digital communication link RS485. If the lead of this link is damaged, the following window will be displayed:



Drawing 50 View of alarm „no communication“

The regulator does not disable regulation and operates as usual, with the pre-programmed

parameters. If an alarm occur, it will take action in accordance with the given alarm. Check the lead connecting the control panel with the executive module and replace or repair it.

19 EXTRA FUNCTIONS

Except for the functions described above, the regulator offers an number of other functions.

19.1 Power supply decay

In the cases of power supply failure, the regulator will resume the operation mode in which it was before the failure.

19.2 Protection against freezing

If the boiler temperature drops below 5°C, the CO pump will be enabled, thus forcing circulation of the boiler water. This will delay the process of water freezing, yet in the case of great frost or shortage of power, it will not protect the system against freezing.

19.3 Preventive cooling

This function consists in attempts to cool the boiler before the regulator switches into permanent boiler overheating alarm. Description can be found in point 18.2.



In the DHW = SUMMER mode, only the DHW pump is enabled preventively.

19.4 Function of protecting pumps against stagnation

The regulator protects the CH, DHW, MIXER and mixer servo pumps against stagnation. It does so by activating them periodically (every 167h for several seconds). This protects the pumps against immobilization due to sedimentation of boiler scale. For this reason, the regulator power supply should be connected also when in the boiler is not in use. This function can be enabled also when the regulator is turned off, via keyboard (regulator in STAND-BY) and in the STOP mode.

20 REPLACEMENT OF PARTS AND SUBASSEMBLIES

When ordering parts and subassemblies, please specify necessary information read off the rating plate. It is best to give the regulator serial number. If the serial number is not known, please specify the model and type of the regulation, as well as the year of its production.



The regulator serial number can be found on a rating plate of the executive module. The number of the control panel is the serial number.

20.1 Replacing mains fuse

The mains fuse is situated in the executive module. It protects the regulator and the devices fed by it.

Please use time-delay fuses, porcelain, 5x20mm, of nominal burnout current 6,3A.

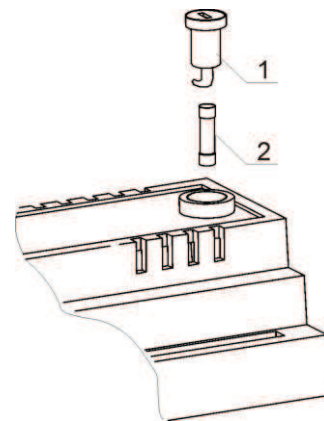

Drawing 51 Fuse replacement, where: 1 – fuse, 2 – fuse socket

In order to remove the fuse, push in its socket with a flat screwdriver and turn it counter clockwise.

20.2 Control panel replacement

Shall it be necessary to replace the whole control panel, check compatibility of the new panel software with the executive panel software. Compatibility is maintained if the first number of software in the control panel and in the executive module is identical. In the example below, the software versions are compatible, as the first number „06“ is the same for both subassemblies:

Examples of software numbers:

Control panel

06.10.010.



Executive module

06.11.026.W0



The software numbers can be read on the rating plates of the subassemblies, or in the display window, right after turning the regulator on.

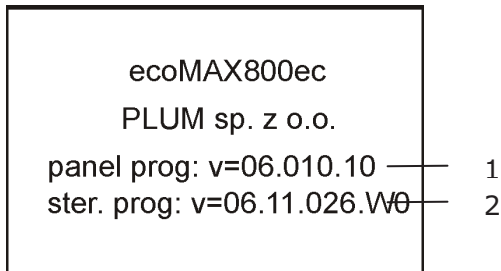

Drawing 52 View of display after turning the regulator on, where: 1 – control panel software number, 2 – executive module software number



The regulator can operate improperly if the control panel is incompatible with the executive module.

20.3 Executive module replacement

The requirements are the same as those for replacement of the control panel, point 20.1

21 Description of possible faults

Signs of a fault	Hints
1. The display is blank despite connection to power supply.	Check: <ul style="list-style-type: none"> ▪ if the main fuse is burnt-out, replace if so, ▪ if the lead connecting the panel with the module is properly plugged in, and if it's not damaged
2. Preset CH temperature on the display is different than the programmed one	Check: <ul style="list-style-type: none"> ▪ whether the domestic hot water tank is filled at the time and the preset domestic hot water temperature is higher than the preset CH temperature; if so, the difference of readouts will disappear after the domestic hot water is filled, or after decreasing the preset domestic hot water temperature. ▪ whether the room thermostat is on – set the service parameter <i>Lower preset CH temp. to thermostat</i> to "0" ▪ if the time periods are on – enable time periods
3. CH pump is inoperative	Check: <ul style="list-style-type: none"> ▪ whether the boiler exceeded the parameter <i>CH pump start temp.</i> – wait or decrease the <i>CH pump start temp.</i> ▪ if the room thermostat is not blocking the CH pump - set the parameter <i>CH pump start temp. with thermostat on</i> to "0". ▪ if the DHW priority, which blocks the central heating pump, is enabled – disable the priority by setting the <i>DHW mode</i> to <i>No priority</i>, ▪ whether the central heating pump is not damaged or clogged.
4. CH pump switches off temporarily	<ul style="list-style-type: none"> ▪ If this happens when the boiler temperature is 10°C lower than the preset boiler temperature, it is a normal symptom connected with detection of fuel shortage
5. The fan is inoperative	<ul style="list-style-type: none"> ▪ increase the fan power (parameter <i>fan power</i>), ▪ check if the safety temperature limiter STB jumper is on terminals 1-2 (the jumper should be placed only if no temperature limiter is connected). ▪ if the boiler manufacturer equipped it with a temperature limiter STB with manual return to the initial position, unlock it by removing the lid and pushing the button, in accordance with the documentation provided by the boiler manufacturer. ▪ Check setting of the parameter <i>Feeder and Fan power</i> and set it to <i>ON</i>, ▪ check the fan and replace it if necessary
6. Fuel feeder inoperative/does not feed	<ul style="list-style-type: none"> ▪ Check if the feeder leads are properly connected to terminals ▪ If temperature limiter STB is connected to terminals 1-2, check if the circuit is not cut off due to boiler overheating, ▪ Check if the feeder motor is in working order, ▪ Check setting of the parameter <i>Fuel feeder and Fan power</i> and set it to <i>ON</i>, ▪ If you can hear the motor working but the fuel is not fed, replace the cotter pin in the fuel feeder coupling, in accordance with the boiler manual
7. When the Fuzzy Logic mode is on, the fuel is not burnt out completely, and there are fuel remnants in the ashes	<ul style="list-style-type: none"> ▪ Open the fan aperture and/or fan return flap to the maximum ▪ Clean ducts which supply air to the furnace ▪ Check if the seal between the fan and the boiler casing is in working order, ▪ Make sure that the proper fuel type is selected (if other fuel types can be selected in the regulator) – in the fuzzy logic mode, combustion of mixed fines and eco-peal coal is not allowed. ▪ Unseal the boiler room window, thus providing sufficient amounts of fresh air.
8. The temperature is	<ul style="list-style-type: none"> ▪ Check if there is good thermal contact between the temperature

measured incorrectly	<p>sensor and the measured surface,</p> <ul style="list-style-type: none"> ▪ whether the sensor lead is not placed too close to the mains cable, ▪ If the sensor is connected to the terminal, ▪ Whether the sensor is not damaged – check it in accordance with point 13.10
9. in the DHW=SUMMER mode, the heaters are hot and the boiler overheats	<ul style="list-style-type: none"> ▪ Increase the parameter <i>Extend DHW pump time</i> in order to cool down the boiler
10. the DHW pump is active even if the DHW tank has been filled	<ul style="list-style-type: none"> ▪ Set the parameter <i>Extend DHW pump time</i> = 0
11. The boiler overheats despite enabled airflow	<ul style="list-style-type: none"> ▪ This could be caused by structural defect of the boiler, or the chimney system, consisting in lack of safeguard against too high a chimney draught

22 Regulator setup by boiler manufacturer.

CAUTION: THE FUZZY LOGIC PROGRAM IS SELECTED INDIVIDUALLY TO THE GIVEN BOILER STRUCTURE. MAKE SURE THAT THE FITTINGS FOR BOILERS TESTED IN THE PLUM LABORATORIES ARE COMPATIBLE WITH FITTINGS FOR SOLD BOILERS. IT IS INADMISSIBLE TO REPLACE THE TYPE OF TRANSMISSION, SCREW COILS, FAN TYPE AND TO MAKE OTHER CONSTRUCTIONAL MODIFICATIONS WHICH CHANGE THE CONDITIONS OF COMBUSTION.

IN THE CASE OF INSTALLING A HIGH-POWER BURNER IN A LOWER POWER BOILER, THE POWER SPECIFIED BY THE REGULATOR MUST BE LIMITED BY PREPARING A SPECIAL SOFTWARE VERSION, E.G. IF A 25kW BURNER IS TO BE INSTALLED IN A 15kW BOILER.

The regulator has a hidden menu for boiler manufacturers, where they can select the type of boiler with which the given regulator is to cooperate. Settings for specific boilers need to be arranged between the boiler manufacturer and the PLUM sp. z o.o. company. After fitting the regulator, the boiler manufacturer selects the boiler type, which causes loading of default values. This logistically simplifies ordering of regulators, as one regulator can, in terms of software, support most boilers of the given manufacturer. In order to enter the hidden MENU, go to:

MENU -> SERVICE SETTINGS -> enter special password.

The special password is made available only to boiler manufacturers.

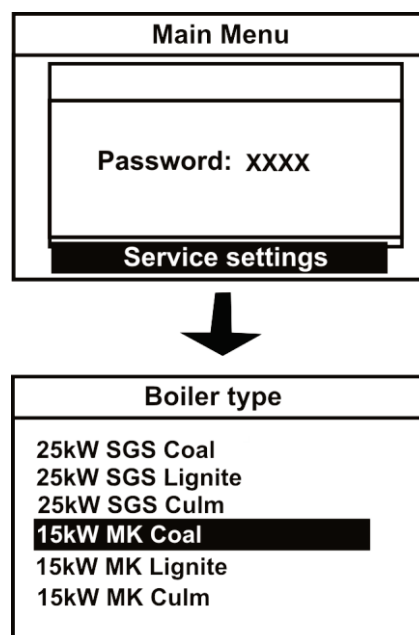

Drawing 53 Selection of boiler and default fuel type for boiler manufacturers

From among the boilers listed in the menu, select the type of boiler in which the regulator is installed. The selected fuel will simultaneously become the default fuel. In the example above, selecting a 15kW MK, coal-fired boiler will make the regulator load stored settings for a 15kW boiler with three types of fuel, and hard coal will be the default fuel. Whereas in the menu available to users and fitters, options for a 15kW MK boiler will appear:

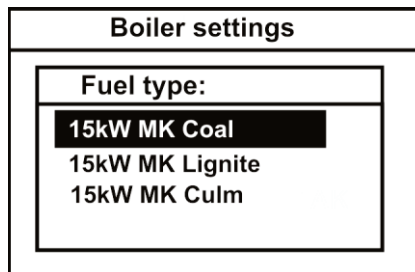

Drawing 54 Selection of fuel for the boiler user

In order to apply the changes, disable and enable mains supply to the regulator.

The regulator has another hidden menu for boiler manufacturers, which allows to read recorded parameters of boiler operation. This allows to check whether the boiler has been operated in conditions required by the manufacturer, as specified in the boiler documentation. In such cases, any disputes arising from complaints can be settled faster, e.g. if they result from lack of securing the boiler return temperature. It is possible to record data from 1024 days back, that is from about 3 years. You can clear the data from the regulator memory only after connecting the regulator to a computer. In order to enter the recording menu, it is necessary to enter the special password when opening the service settings.

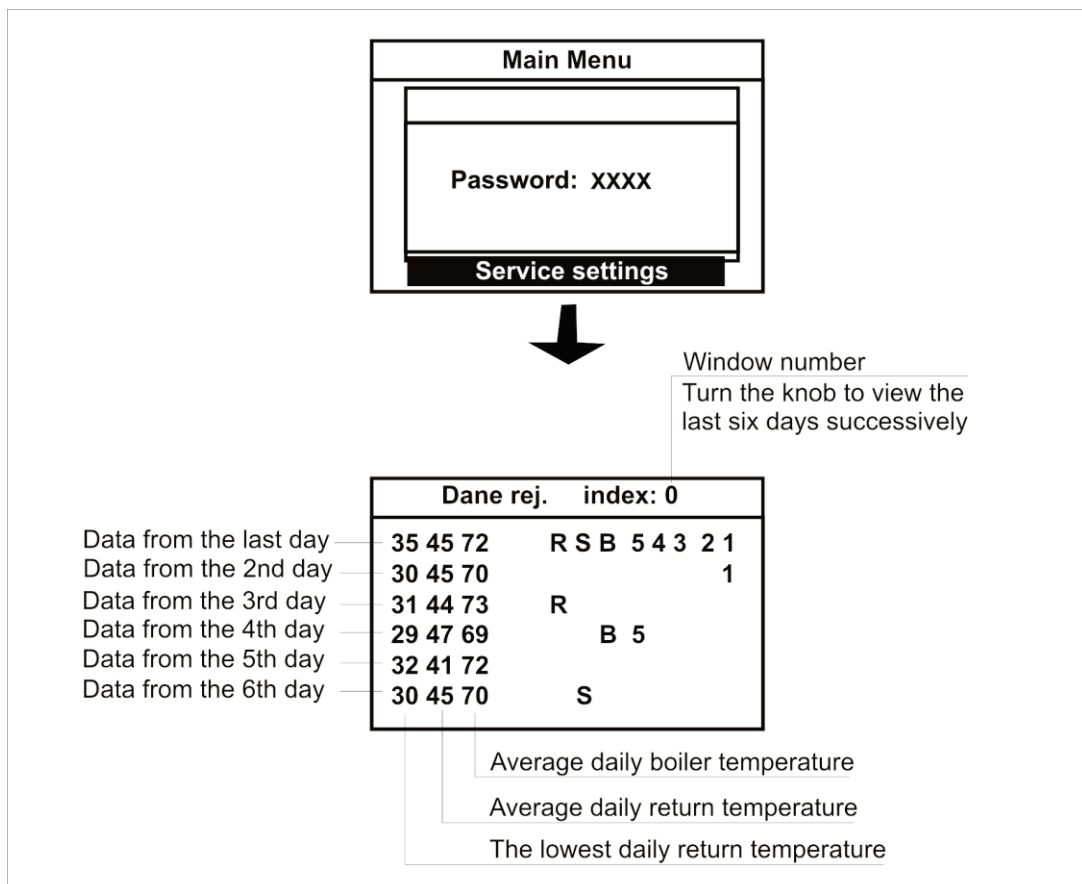

Drawing 55 Readout of stored parameters

Legend:

- R – there has been a „reset“ during the previous day (24 hours), i.e. a momentary or prolonged interruption in the boiler power supply,
- S – within the last day (24 hours), the user enabled the STOP mode of the regulator, or they turned it off – for a moment or for a longer period,
- B – „no sensor“, within the last day (24 hours), the return sensor was disconnected or damaged, for a moment or for a longer period,

1 – within the last day (24 hours), alarm 1 occurred, analogically for alarm 2, etc.

No.	alarm name
1	No fuel
2	Boiler overheated
3	Flame recessed to retort
4	Boiler temperature sensor damage
5	Feeder temperature sensor damage

Caution: A temperature record of about 108°C is an evidence that the sensor was disconnected. Values recorded for a given day are stored in the memory at 00.00.

